

THE Radio Constructor

RADIO
TELEVISION
AUDIO
ELECTRONICS

VOLUME 17 NUMBER 9
A DATA PUBLICATION
PRICE TWO SHILLINGS

April 1964

Transistorised Vibrato Unit



Model Control Pocket
Wavemeter/Monitor

■ Tone-Operated
Switching Circuit

■ 3-Transistor
VHF Receiver

■ Electronic
"Watch Dog"



A sustained demand for the Mullard "Reference Manual of Transistor Circuits" has led to a further printing of the second edition. Over 35,000 copies of this important reference work have been sold to technicians, service engineers, junior designers and electronics students. Whatever your interest in transistor circuitry you will find this Manual a proved and valuable source of reference — comprising 300 pages, with 241 diagrams, and describing more than 60 circuits.

Get a copy of the Mullard "Reference Manual of Transistor Circuits" from your local Radio Dealer or direct from Mullard Ltd. (Postage and packing, 1s. extra.) Overseas readers should enquire at their local Mullard Agents.

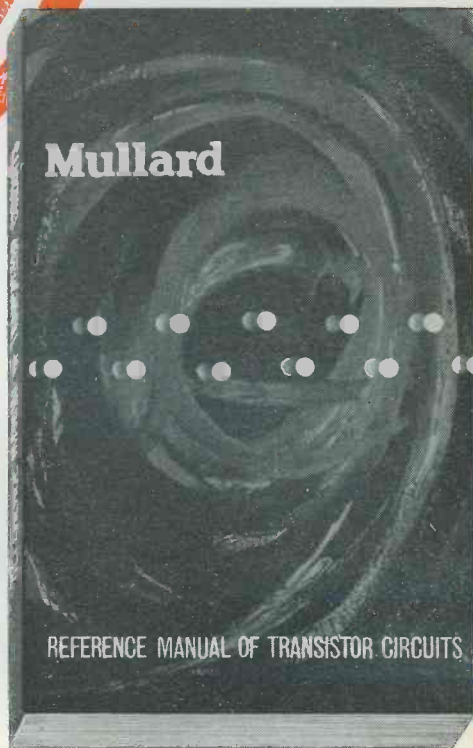

UK Price 12/6d.

Published by—



MULLARD LIMITED • DEPT. C • MULLARD HOUSE • TORRINGTON PLACE • LONDON • W.C.1

MVM 3259

LASKY'S RADIO

FOR THE FINEST RANGE OF TRANSISTOR RECEIVERS

We consider our construction parcels to be the finest value on the home constructor market. If on receipt you feel not competent to build the set, you may return it as received within 7 days, when the sum paid will be refunded, less postage.



THE SKYROVER

Controls: Waveband Selector, Volume Control with On/Off Switch, Tuning Control. In plastic cabinet, size 10" x 6 1/2" x 3 1/4", with metal trim and carrying handle.

Can be built for **£10.19.6**
H.P. Terms:—22/- dep. & 11 months at 21/-
P. and P. 5/- extra

THE SKYROVER and the SKYROVER DE LUXE

GENERAL SPECIFICATION. 7 transistor plus 2 diode superhet, 6 waveband portable receiver. Operating from four 1.5V torch batteries. The SKYROVER and SKYROVER DE LUXE cover the full medium waveband and short waveband 31-94 M, and also 4 separate switched band-spread ranges, 13 M, 16 M, 19 M and 25 M, with band-spread tuning for accurate station selection. The coil pack and tuning heart is completely factory assembled, wired and tested. The remaining assembly can be completed in under three hours from our easy to follow, stage by stage instructions.

SPECIFICATION: Superhet, 470 kc/s. All Mullard transistors and diode. Uses 4 U2 batteries. 5" Ceramic Magnet P.M. Speaker. Easy to read Dial Scale. Band-spread Tuning. 500mW Output. Telescopic Aerial and Ferrite Rod Aerial.

WAVEBAND COVERAGE: 180-576 M, 31-94 M, and band-spread on 13, 16, 19 and 25 metre bands.

All components available separately. Four batteries included free. Data for each receiver, 2/6 extra, refunded if you purchase the parcel.



THE SKYROVER DE LUXE

Tone Control circuit is incorporated, with separate Tone Control in addition to Volume Control, Tuning Control and Waveband Selector. In a wood cabinet, size 11 1/2" x 6 1/2" x 3", covered with a washable material, with plastic trim and carrying handle. Also car aerial socket fitted.

Can be built for **£12.19.6**
H.P. Terms:—26/- deposit and 11 months at 24/6
P. and P. 5/- extra

READY BUILT BARGAINS

BOY'S TRANSISTOR RADIO. Ready built, 2-transistor pocket radio. In attractive plastic case. Size only 4" x 2 1/2" x 1". Fitted with 2 1/2" loudspeaker. Socket for personal earpiece and telescopic aerial. Works from single PP3-type battery. Fully tunable over full Medium waveband. Supplied complete with earpiece, telescopic aerial, carrying purse and 9 volt battery. Ideal Birthday Present.

LASKY'S PRICE **42/-**
with all accessories. Post Free.



6-Transistor Pocket Radio. Fully built. 4" x 2 1/2" x 1", with 2 1/2" speaker. Uses single PP3-type battery. Supplied complete with personal ear-piece and leather case. Tunable over full Medium waveband. LASKY'S PRICE **79/6** complete with all accessories. Post Free.

TRANSFILTERS by BRUSH CRYSTAL CO.

TO-01B 465 kc/s ± 2 kc/s
TO-01D 470 kc/s ± 2 kc/s
TO-02B 465 kc/s ± 1 kc/s
TO-02D 470 kc/s ± 1 kc/s
TF-01B 465 kc/s ± 2 kc/s
TF-01D 470 kc/s ± 2 kc/s

6/6 each
P. & P. 6d.

RECORDING TAPE SPLICER

By famous manufacturer, all metal nickel plated construction. With separate razor blade—securely clamps tape while splicing. Listed at 18/6 LASKY'S PRICE **14/6** Post Free

GUITAR PICK-UP

Crystal—high imp. Size only 1 1/2" x 2" x 1/2". Clips to fingerboard—no screws. Complete with cable.

LASKY'S PRICE **15/11** P. & P. 1/-

The "Sixteen" Multirange METER KIT



This outstanding meter was featured by Practical Wireless in the January 1964 issue. Lasky's are now able to offer the complete kit of parts as specified by the designer. The "Sixteen" Multirange offers the home constructor and serviceman an instrument that will meet most of his requirements for voltage, current and resistance measurement. There are 16 switched ranges: 9 for voltage measurement, 4 current ranges and 3 resistance ranges. All British components are used throughout. The instrument case is supplied with the meter movement built-in. The two scales are clearly printed in black on white and are very easy to read.

RANGE SPECIFICATION
D.C. volts: 0-2.5-25-250-500 at 20,000Ω/V.
A.C. volts: 0-25-50-250-500 at 1,000Ω/V.
D.C. current: 0-50μA, 0-2.5-50-250mA.
Resistance: 0-2,000Ω, 0-200kΩ, 0-20MΩ.
Basic movement: 40mA f.s.d. moving coil. With universal shunt full scale deflection current is 50mA.
Size/finish: Black plastic case 3 1/2" x 5 1/2" x 1 1/2".
Controls: 12 position range switch; separate slide switch for A.C.v olts—D.C. ohms; ohms zero adjustment pot. meter; meter zero.
External connections: Two 4mm sockets for test lead plus.
Power requirements: One 15V and one 1.5V batteries. Complete with all parts and full construction details.

This offer is exclusive to Lasky's!

LASKY'S PRICE **£5.19.6**
P. & P. 5/-
H.P. Terms:—21/- dep. and 5 months at 21/-
Data and circuit available separately 2/6, refunded if all parts bought. Pair of batteries, 2/6 extra.

REALISTIC SEVEN

★ 7-transistor Superhet. ★ 350 milliwatt output into 4" high flux speaker. ★ All components mounted on a single printed circuit board, size 5 1/2" x 5 1/2" in one complete assembly. ★ Plastic cabinet with carrying handle, size 7" x 10" x 3 1/4" in Red/ Grey, Blue/Grey or all Grey. ★ Easy to read Dial. ★ External socket for car aerial. ★ I.F. frequency 470 kc/s. ★ Ferrite rod internal aerial. Operates from PP9 or similar battery. ★ Full comprehensive data supplied with each receiver. ★ All coils and I.F.s, etc., fully wound ready for immediate assembly.



An Outstanding Receiver. LASKY'S PRICE for the complete parcel including Transistors, Cabinet, Speaker, etc., and Full Construction Data. Can be built for: **£5.19.6**

P. and P. 4/6
PP9 Battery, 3/9. Data and instructions separately, 2/6. Refunded if you purchase the parcel.

REALISTIC 'Seven' De Luxe

With the same specification as standard model—PLUS a superior wood cabinet in contemporary styling. ALSO a full vision circular dial

FOR ONLY **£1** EXTRA
P. & P. as std. model

THE SPRITE

CAN BE BUILT FOR **79/6** P. and P. 3/6 extra



★ Six-Transistor Superhet Miniature Personal Pocket Radio
★ Long and medium wavebands
★ Ferrite Rod Aerial
★ I.F. Freq. 470 kc/s
★ 3" speaker

★ Printed circuit 2 1/2" x 2"
★ In Plastic Case. Size 4" x 2 1/2" x 1".

In order to ensure perfect results, the SPRITE is supplied to you with R.F. and L.F. stages. Driver and output stages ready built with all components mounted on the printed circuit. The SPRITE pre-assembled, plus cabinet, speaker and all components for final construction, can be built for 79/6. Postage and package 3/6 extra. Data and instructions separately 2/6. Refunded if parcel is purchased. Real calf leather case, wrist strap, personal earphone and case for earphone and battery, 12/6 the lot extra. Make no mistake, this is a SUPERHET receiver of genuine commercial quality. It is not a regenerative circuit.

HEADPHONES

S. G. Brown type F earphones—moving iron 2,000Ω. Hand-held type, but a headband could easily be fitted.

LASKY'S PRICE **14/6 PAIR** P. & P. 1/6

TRANSISTORS

All New and Guaranteed
GET.S1, GET.S5, GET.S6-2/6; 837A, 874P-3/6; OC.45, OC.71, OC.81D-4/6; OC.44, OC.70, OC.76, OC.81 (matched pair 10/6)-5/6; AF.117, OC.72, OC.75, OC.170, OC.171, OC.82D-6/6; OC.25, OC.42, OC.43, OC.73, OC.82D-7/6; OCF.71-9/6; OC.28, OC.201, OC.204-15/-; OC.205, OC.206-19/6.

33 TOTTENHAM COURT ROAD · W1

2 mins. Oxford St. Nearest Station: Goudge St.
MUSEum 2605

Tottenham Ct. Rd. & Edgware Rd. addresses open all day Sat. Close 1 Thur. Please address all Mail Orders to Dept. W at above Edgware Road address

207 EDGWARE ROAD · W2

Few yards from Praed St.
PADddington 3271/2

152/3 FLEET STREET · EC4

(ELECTRONICS Fleet St. Ltd) FLEet 2833.
Open all day Thurs. Closed 1 p.m. Sat.

HI-FI AMPLIFIERS TUNERS RECORD PLAYERS

S-33



S-99



GL-58



MA-12



HI-FI 6W STEREO AMPLIFIER. Model S-33. 3 watts per channel 0.3% distortion at 2.5W/chnl., 20dB N.F.B. Inputs for Radio (or Tape) and Gram, Stereo or Monaural, ganged controls. Sensitivity 200mV. **£13.7.6**

DE LUXE STEREO AMPLIFIER. Model S-33H. De luxe version of the S-33 with two-tone grey perspex panel, and higher sensitivity necessary to accept the Decca Deram pick-up. **£15.17.6**

HI-FI STEREO AMPLIFIER. Model S-99. 18W output. Ganged controls. Stereo/Mono gram., radio and tape inputs. Push-button selection. Printed circuit construction. **£27.19.6**

POWER SUPPLY UNIT. Model MGP-1. Input 100/120V, 200/250V. 40-60 c/s. Output 6.3V, 2.5A A.C. 200, 250, 270V, 120mA max. D.C. **£5.2.6**

A wide range of American equipment available under direct mail order scheme. Full details and catalogue 1/- post paid.

GOLDRING LENCO TRANSCRIPTION PLAYER. Model GL-58. With G-60 pick-up arm and Ronette 105 cartridge. **£18.19.2**

GARRARD AUTO/RECORD PLAYER. Model AT-6. With R 105 cartridge. **£13.12.1** With Decca Deram pick-up **£14.6.1**

SUGDEN MOTOR UNIT "CONNOISSEUR CRAFTSMAN". Heavy duty motor operating at 33 $\frac{1}{2}$ and 45 r.p.m. Very heavy 12" turntable. Virtually no rumble. **£16.6.6**

HI-FI MONO AMPLIFIER. Model MA-5. A general purpose 5W Amplifier, with inputs for Gram., Radio. Presentation similar to S-33. **£10.19.6**

HI-FI MONO AMPLIFIER. Model MA-12. 12W output, wide freq. range, low distortion. **£11.18.0**



Enjoy Yourself and Save Money

TEST INSTRUMENTS

New!

5" GENERAL-PURPOSE LABORATORY OSCILLOSCOPE. Model IO-12U. This outstanding oscilloscope, with its professional specification and styling, fulfills most laboratory and service requirements. Vertical frequency response 3 c/s to over 5 Mc/s, sensitivity 10mV r.m.s. per cm. at 1 kc/s. T/B covers 10 c/s—500 kc/s. Please send for full details. **£32.12.6**

2 $\frac{1}{2}$ " PORTABLE SERVICE SCOPE. Model OS-1. This is a light, compact oscilloscope, ideal for servicing, etc. Dimensions 5" x 8" x 14 $\frac{1}{2}$ " long. Weight 10 $\frac{1}{2}$ lb. **£21.18.0**

ELECTRONIC SWITCH. Model S-3U (Oscilloscope Trace Doubler). Enables a single beam oscilloscope to give simultaneous traces of two separate and independent signals. Switching rates approx. 150, 500, 1,500, 5,000 and 15,000 c/s. Sig. freq. response 0-100 kc/s. \pm 1dB. Separate gain controls and sync. output. Sig. input range 0.1-1.8V r.m.s. **£12.18.0**

AUDIO SIGNAL GENERATOR. Model AG-9U. 10 c/s to 100 kc/s, switch selected. Distortion less than 0.1%. 10V sine wave output metered in volts and dB's. **£22.10.0**

RESISTANCE/CAPACITANCE BRIDGE. Model C-3U. Measures capacity 10pF to 1,000 μ F, resistance 100 Ω to 5M Ω and power factor. 5-450V test voltages. With safety switch. **£10.10.0**

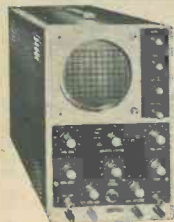

IO-12U



S-3U



C-3U

New! **DE LUXE LARGE-SCALE VALVE VOLTMETER. Model IM-13U.** Circuit and specification based on the well known model V-7A but with many worthwhile refinements. 6" Ernest Turner meter. Unique gimbal bracket allows operation of instrument in many positions. Modern styling. Please send for full details **£18.18.0**

CAPACITANCE METER. Model CM-1U. Direct-reading 4 $\frac{1}{2}$ " scale. Full-scale ranges 0-100 μ F, 0-1,000 μ F 0-0.01 μ F and 0-0.1 μ F. **£15.15.0**

VALVE VOLTMETER. Model V-7A. 7 voltage ranges d.c. volts to 1,500. A.C. to 1,500 r.m.s. and 4,000 peak to peak. Resistance 0.1 Ω to 1,000M Ω with internal battery. D.C. input impedance 11M Ω . dB measurement, has centre-zero scale. Complete with test prods, lead and standardizing battery. **£13.18.6**

MULTIMETER. Model MM-1U. Ranges 0-1.5V to 1,500V A.C. and D.C.; 150 μ A to 15A D.C.; 0.2 Ω to 20M Ω . 4 $\frac{1}{2}$ " 50 μ A meter. **£12.18.0**

R.F. SIGNAL GENERATOR. Model RF-1U. Up to 100 Mc/s fundamental and 200 Mc/s on harmonics and up to 100mV output on all bands. **£13.8.0**



IM-13U



V-7A



RF-1U

ALL MODELS ALSO AVAILABLE ASSEMBLED AND TESTED. PRICES AND FULL SPECIFICATIONS ON REQUEST

TRANSISTOR RADIOS

LATEST MODEL! "OXFORD" LUXURY PORTABLE. Model UXR-2. Specially designed for use as a domestic, car or personal portable receiver. Many features, including solid leather case. **£14.18.0**

TRANSISTOR PORTABLE. Model UXR-1. Pre-aligned I.F. transformers, printed circuit. Covers L.W. and M.W. Has 7" x 4" loudspeaker. Real hide case. **£12.11.0**

TRANSISTOR PORTABLE RECEIVER. Model RSW-1. In a handsome leather case, it has retractable whip aerial and socket for car radio use. Covers Med., Trawler and two S wave bands. **£19.17.6**

JUNIOR TRANSISTOR RADIO. Model UJR-1. Single transistor set. Excellent introduction to radio. **£2.7.6**



UXR-2



UXR-1



UJR-1

FOR THE INSTRUMENTALIST



PA-1

PA AMPLIFIER PA-1. The ideal compact unit for VOCALISTS, INSTRUMENTALISTS, RECORDS, with 50W (100W pk output), 2 Heavy Duty Speakers. Variable TREMOLO. Elegant modern cabinet. Send for full specification. **£54.15.0**
Legs optional extra 17/6 set of 4.

ELECTRONIC ORGAN (fully transistorised)
Ideal for Soloists, Home use, Groups. Full 20 WATTS VOLUME. Matching bench **£14.10.0** extra. **£187.10.0**

Money-back Guarantee

Daystrom Limited unconditionally guarantees that each Heathkit product assembled in accordance with our easy-to-understand instruction manual must meet our published specifications for performance or the purchase price will be cheerfully refunded.

TAPE DECKS CONTROL UNITS TAPE AMPLIFIERS



COLLARO



D-83/4



FM-4



AM/FM

COLLARO "STUDIO" TAPE DECK. The finest buy in its price range. Operating speeds: 1½", 3½" and 7½" p.s. Two tracks "wow" and "flutter" not greater than 0.15% at 7½" p.s. **£17.10.0**

TRUVOX D93/2 & D83/4 TAPE DECKS. High quality mono/stereo tape decks.

D93/2, 2 track, £36.15.0 D83/4, 4 track, £29.8.0

HI-FI AM/FM TUNER. Model AFM-1. Available in two units which, for your convenience, are sold separately. Tuning heart (AFM-T1—£4.13.6 incl. P.T.) and I.F. amplifier (AFM-A1—£21.16.6). Printed circuit board, 8 valves. Covers L.W., M.W., S.W., and F.M. Built-in power supply. **Total £26.10.0**

HI-FI FM TUNER. Model FM-4U. Also available in two units. R.F. tuning unit (£2.15.0 incl. P.T.) with I.F. output of 10.7 Mc/s, and amplifier unit, with power supply and valves (£13.3.0). **Total £15.18.0**

TAPE RECORDING/PLAYBACK AMPLIFIER. Thermometer type recording indicators, press-button speed compensation and input selection. Mono Model TA-1M, **£19.18.0** Stereo Model TA-1S, **£25.10.0**

MONO CONTROL UNIT. Model UMC-1. Designed to work with the MA-12 or similar amplifier requiring 0.25V or less for full output. 5 inputs. Baxandall type controls. **£8.12.6**

STEREO CONTROL UNIT. Model USC-1. Push-button selection, accurately matched ganged controls to ±1dB. Negative feedback, rumble and variable low-pass filters. Printed circuit boards. **£19.10.0**

Building these Heathkit models



SPEAKER SYSTEMS

HI-FI SPEAKER SYSTEM. Model SSU-1. Ducted-port bass reflex cabinet "in the white". Two speakers. Vertical or horizontal models with legs **£11.12.0** without legs **£10.17.6**.

THE "COTSWOLD". This is an acoustically designed enclosure 26" x 23" x 15½" housing a 12" bass speaker with 2" speech coil, elliptical middle speaker together with a pressure unit to cover the full frequency range of 32-20,000 c/s. Capable of doing justice to the finest programme source, its polar distribution makes it ideal for really Hi-Fi Stereo.

COTSWOLD "MFS" SYSTEM. Specially developed to give best possible results in small rooms. This minimum floor space model is based on standard Cotswold. Size: 36" high x 16½" wide x 14½" deep. Either Model **£23.4.0**



SSU-1



MFS

HI-FI EQUIPMENT CABINETS



"GLOUCESTER"

A wide range of equipment cabinets are available to meet the differing needs of enthusiasts. Designed for max. operating convenience or for where room space is an overriding consideration this range includes kits, ready assembled cabinets or fully finished cabinets, and has at least one model to suit your requirements. Send for full details.

Other models from our wide range include

NEW! SELF SUPPORTING AERIAL TOWER, Model HT-1. for Commercial TV, fringe TV reception, Radio Amateur use. 32 ft. high, square section (full erection instructions). HT-1G (gal finish) **£35.15.0**. HT-1 (red oxide finish) **£29.15.0**. Range of accessories, TV, VHF, FM aeriels, etc.

All models also available assembled
Deferred Terms over £10

Send coupon for **FREE** illustrated British catalogue of Heathkit range to:

DAYSTROM LTD DEPT. RC.4
GLOUCESTER

AMATEUR EQUIPMENT



SB-10U



DX-40U

SINGLE SIDEBAND ADAPTOR. Model SB-10U. May be used with most A.M. transmitters. Less than 3W R.F. input power required for 10W output. Operation on 80, 40, 20, 15 and 10m bands on U.S.B., L.S.B. or D.S.B. **£39.5.0**

AMATEUR TRANSMITTER. Model DX-40U. Covers all amateur bands from 80 to 10 metres; crystal controlled. Power input 75W C.W., 60W peak controlled carrier phone. Output 40W to aerial. Provision for V.F.O. Filters minimise TV interference. **£33.19.0**

New Model RG-1

COMMUNICATIONS TYPE RECEIVER.

A high performance, low cost receiver for the discriminating listener. Frequency coverage: 600 kc/s-1.5 Mc/s and 1.7 Mc/s-32 Mc/s. Send for full specification. **£39.16.0**

VARIABLE FREQUENCY OSCILLATOR. Model VF-1U. Calibrated, 160-10 m. Fundamentals on 160 and 40m. Ideal for our DX-40U and similar transmitters. **£10.17.6**

AMATEUR BANDS RECEIVER. Model RA-1. To cover all the Amateur Bands from 160-10 metres. Many special features, including: half-lattice crystal filter; 8 valves; signal strength "S" meter; tuned R.F. Amplifier Stage. Send for spec. **£39.6.6**

THE "MOHICAN" GENERAL COVERAGE RECEIVER. Model GC-1U. With 4 piezo-electric transmitters, variable tuned B.F.O. and Zener diode stabiliser, this is an excellent fully transistorised general purpose receiver for Amateur and Short wave listeners. Printed circuit boards, telescopic whip antenna, tuning meter and large slide-rule dial, 10 transistors. **£37.17.6**

AMATEUR TRANSMITTER. Model DX-100U. The world's most popular, compact and completely self-contained Amateur Transmitter. Covers all amateur bands: 160-10 m. 150W d.c. input. Careful design has achieved the stability and high performance for which the DX-100U is noted and no less than 35 disc ceramic capacitors reduce TVI to a minimum. **£79.10.0**



RG-1



RA-1

A wide range of American amateur equipment. See Mail Order Scheme.

Without obligation please send me

FREE BRITISH HEATHKIT CATALOGUE (Tick here)

FULL DETAILS OF MODEL(S)

(Please write in BLOCK CAPITALS)

NAME _____

ADDRESS _____

DEPT. RC.4

This is what Sinclair service means to you

WORLD LEADERSHIP

Within an amazingly short time, Sinclair Radionics has leapt forward to become a world-leader in its own specialised field of micro-electronic designs for the home constructor. The reasons for this are not hard to find, and even if, at first, they appear simple, they represent as much of a breakthrough in relations between customer and supplier as do the designs which we have introduced.

SPECIALIST TEAMS

Our object is to produce micro-electronic transistor designs which are not simply interesting to build, but which are well ahead of anything offered by our competitors. They are also technically ahead of any available manufactured products. To achieve these standards, we employ our own highly qualified team of electronic engineers, and when they have contributed their share to a design, we "marry" it to the services of an industrial design group to ensure that our cases are both elegant and functionally right. Developments on these lines are going on all the time in the carefully planned Sinclair programme.

INSTRUCTIONS

Presentation of instructions is another Sinclair feature in which we naturally take pride. The experienced builder will readily recognise and appreciate the quality of the circuits shown in the Instructions. Equally important, however, is that *anyone* with or without technical knowledge can build a Sinclair design with 100% success from the word "Go".

FEATURED ON THE FOLLOWING PAGES :

SINCLAIR MICRO-6

The smallest radio in the world

SINCLAIR SLIMLINE

Designed for easy, high-speed assembly

SINCLAIR MICRO-INJECTOR PROBE

A better instrument for fault finding

SINCLAIR AMPLIFIERS

SINCLAIR TRANSISTORS

CONSTRUCTIONAL BOOKS

With the Micro-6, for example, building is actually proving easier than even we believed at first, and already there are thousands in use.

SATISFYING THE CUSTOMER

How about you, the customer? We insist on your being completely satisfied in all your dealings with us. In fact, we have a special service department run solely to help and advise customers and to correct any errors in assembly which may have inadvertently been made. You need never feel that we will not be interested in your particular problem, no matter how slight it might appear to you. That we are genuinely willing and glad to be of help is something extra which even we cannot properly convey in the unique guarantee offered in our advertisements. We can only tell you of the hundreds of letters which we receive every week from all over the world praising both our service and our designs. *Full details of these appear on the following pages.*

Chris Farrard

Introducing

Mike Farrard

a rare character created for Sinclair Electronics by Ken Ward



PERFORMANCE BEYOND ALL EXPECTATION

SIZE $1\frac{4}{5}$ " x $1\frac{3}{10}$ " x $1\frac{1}{2}$ "

●
IMMENSE POWER AND QUALITY

●
PLAYS IN CAR, TRAIN, BUS, PLANE

●
WITH SELF-CONTAINED FERRITE ROD AERIAL AND BATTERIES

●
A WORLD-BEATING BRITISH DESIGN

We knew that really efficient micro-size radio sets were always wanted; we knew how to get the very best out of modern transistors. After we had designed and field-tested the Micro-6 to our complete satisfaction, we released it for constructors only a few weeks ago. What even we hardly expected was the absolutely fantastic performance reports that are daily reaching us in ever-growing numbers from all over the country (and abroad too). Range, selectivity, power and quality—the four essentials to any good radio are here in more than generous measure—and you can easily build the Micro-6 in a single evening by following the interesting instructions manual.

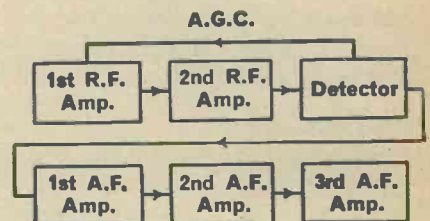
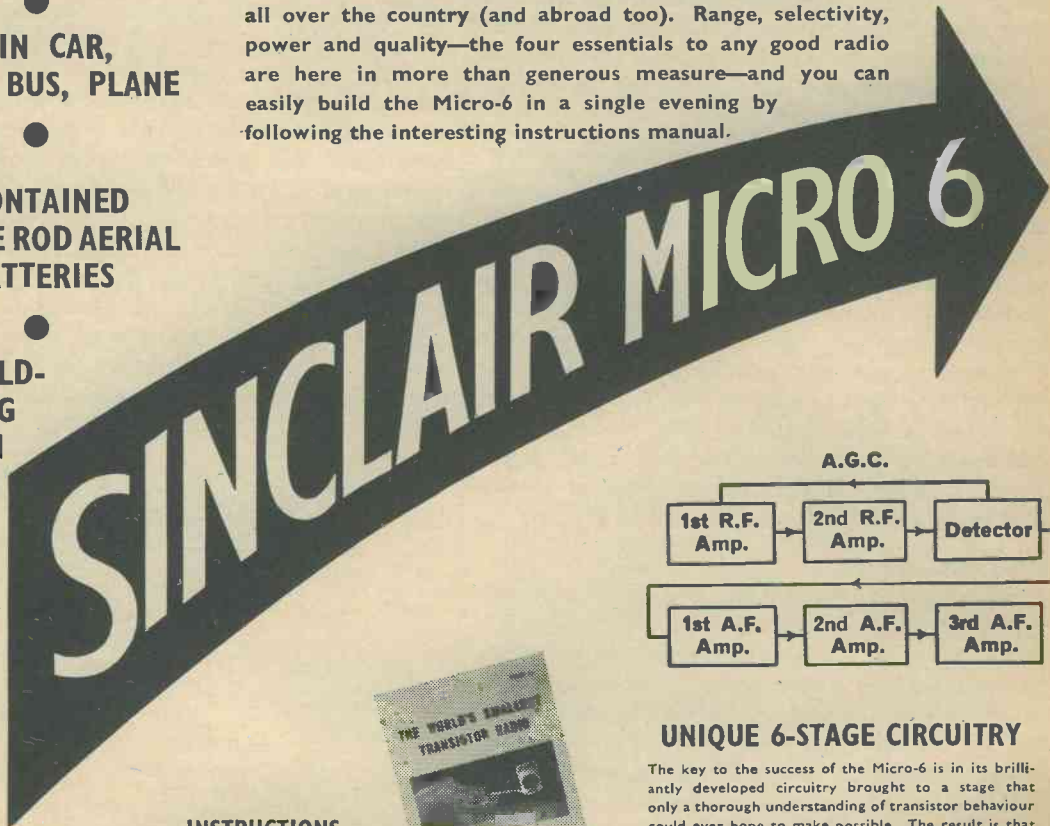

UNIQUE 6-STAGE CIRCUITRY

The key to the success of the Micro-6 is in its brilliantly developed circuitry brought to a stage that only a thorough understanding of transistor behaviour could ever hope to make possible. The result is that within this minute assembly you have a set actually better in performance than that of most transistor superhets many times larger and costlier.

ALL FOR ONLY **59/6**

Price includes cost of all parts, elegant case, lightweight earpiece and plug, and instructions.
MALLORY ZM312 Mercury Cells, 1/11 each

INSTRUCTIONS MANUAL

You will be delighted with the way in which this is presented. The illustrations are exceptionally easy to follow, and stage-by-stage details show just how simple this set is to build.



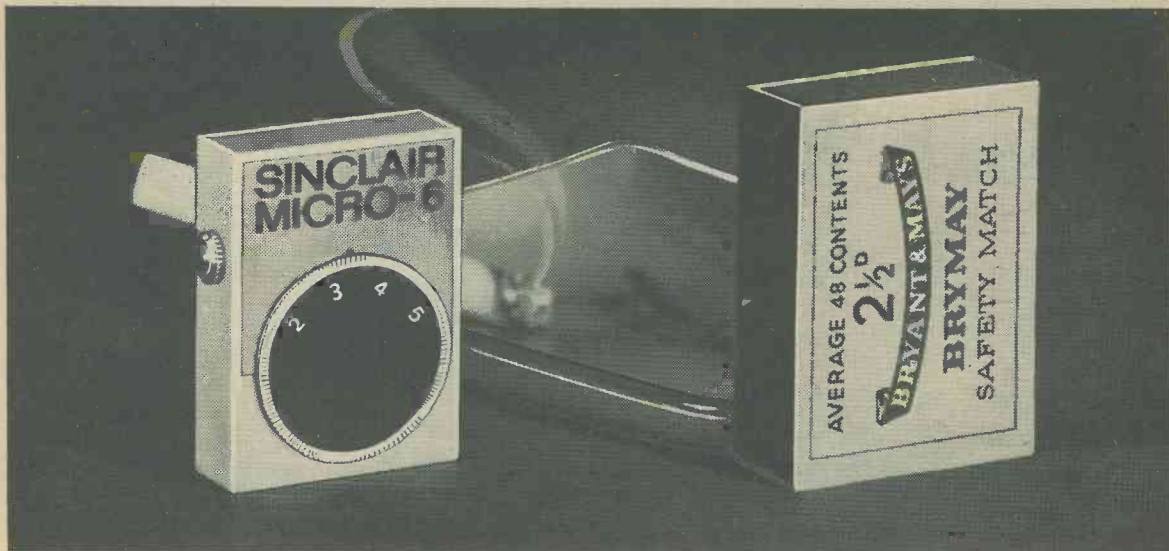

the world's smallest radio

YOU CAN BUILD IT IN AN EVENING

TECHNICAL DESCRIPTION

THE SINCLAIR MICRO-6 uses Micro-Alloy Transistors (MATs) in a completely new circuit comprising six stages. Two stages of R.F. amplification are followed by an efficient double-diode detector which drives a high gain three stage A.F. amplifier. Powerful A.G.C. is applied to the first R.F. stage to ensure fade-free reception of the most distant station, and tuning covers the entire medium waveband. This is widened out at the high frequency end to provide improved separation of Continental stations. The tiny ferrite rod aerial and earpiece socket were both specially designed for this set. This socket incorporates a switch which operates automatically on inserting the earpiece plug, and switches off when the plug is withdrawn. Listening is by means of the high-impedance lightweight earpiece provided. Quality of reproduction is outstandingly good. Instructions for building the Micro-6 set a new standard of clarity and simplicity. The diagrams are a masterpiece of technical illustration and the text contains all the information you require.

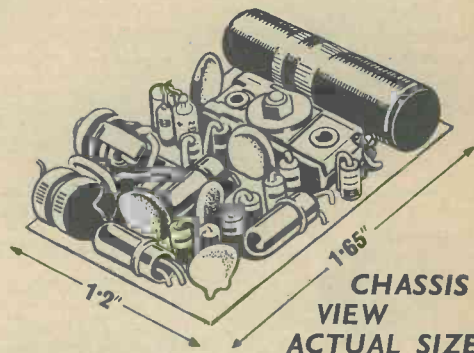

PROFESSIONALLY STYLED IN EVERY DETAIL

Outside—a compact elegant case only 1 1/5" x 1 3/10" x 1/4" with positive drive vernier-action tuning dial, the whole trimmed with gold and black.

Inside—beautifully designed printed circuit assembly, a masterpiece of compactness and electronic efficiency, yet building could hardly be easier.

All parts for building, etc., come to **59/6**

UNIQUE SINCLAIR GUARANTEE

If you are not completely satisfied with your purchase (we are confident that you will be delighted) your full purchase price will be refunded instantly and without question.

FULL SERVICE FACILITIES AVAILABLE TO ALL SINCLAIR CUSTOMERS

SINCLAIR RADIONICS LTD
69 HISTON ROAD, CAMBRIDGE

If you do not wish to cut coupon, please mention RC.4 when ordering

To SINCLAIR RADIONICS LTD., 69 HISTON ROAD CAMBRIDGE

Please send parts for building Micro-6 Receiver(s) and
 Mallory Cell(s) Type ZM312 at 1/11 each for which I enclose
 £ s d.

NAME

ADDRESS

RC.4 A

SINCLAIR

DESIGNS THAT ARE YEARS AHEAD

The triumph of Sinclair designs is twofold—firstly they embody advanced techniques using transistors and micro-miniature components in a variety of attractive applications; secondly they make it possible for anyone to build with assured ease and success and thereby enjoy using really advanced equipment. All designs are provided with well-presented instructions.

- ★ FULL SERVICE FACILITIES AVAILABLE TO ALL SINCLAIR CUSTOMERS
- ★ PROMPT, PERSONAL ATTENTION TO ALL ORDERS

SINCLAIR MICRO-AMPLIFIER

AS USED IN LABORATORIES, RESEARCH ESTABLISHMENTS, ETC.



Actual size

Smaller than a 3d. piece.

★ With detailed instructions, applications data and circuitry

28/6

This fantastically small, powerful amplifier is smaller than a 3d. piece. With a frequency response from 30 to 50,000 c/s \pm 1dB, and power gain of 60dB (1,000,000 times) it makes a superb broadband R.F. amplifier as well as a sub-miniature hi-fi amplifier with an output suitable for any earpiece or even loudspeaker. This amplifier makes a valuable tool in the hands of the experimenter, and is widely used in industry, research, etc. With MAT Transistors, micro-miniature quality components, micro-printed circuit and instructions.

40 dB gain at 1 Mc/s.

FIRST OF THE SINCLAIR MICRO-RECEIVERS



SINCLAIR SLIMLINE

All parts, including royal blue and gold case, earpiece, and instructions, come to

49/6

This is the set that gives you Europe in the palm of your hand. It has a self-contained ferrite rod aerial and accommodation for a standard PP5 battery, yet measures only 2 15/16" x 1 11/16" x 3/8". Tunes over the entire medium waveband and can be used in cars, trains and buses. Using Sinclair MAT Transistors and special circuitry, it provides great power and quality; listening is by means of the lightweight earpiece provided. Building is particularly easy.

SINCLAIR MICRO-INJECTOR

THE SMALLEST AND MOST EFFICIENT OF ALL INJECTOR TEST DEVICES



It is amazing how useful this precision instrument is. Using two MICRO-ALLOY TRANSISTORS it generates and injects a test signal into any part of a receiver or amplifier at any frequency from 1 kc/s to 30 Mc/s. By this means the location of faults can be rapidly found.

The Sinclair Micro-Injector is powered by a 6d. standard battery which will last for about 6 months. Its size is 1 4/5" x 1 3/10" x 1/2", excluding the probe which is 3/5" long, by far the smallest instrument of its kind available. Assembly is extremely simple.

All parts with instructions come to

27/6

Ready built and tested

32/6

3 VALUABLE BOOKS FOR THE CONSTRUCTOR



- ★ "22 Tested Circuits Using Micro Alloy Transistors" Post free 5/6
- ★ "Tested Short Wave Receivers Using MATs" Post free 5/6
- ★ "Tested Superhet Circuits for Short Wave and Communication Receivers, using MATs" Post free 6/6

All three ordered together, 16/6

SINCLAIR TR5 QUALITY AMP.

WITH COMBINED PRE-AMP. AND 1/2 WATT POWER AMPLIFIER

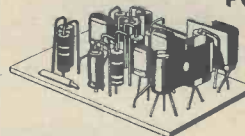

Uses 5 matched transistors and temperature compensating diode to give transformerless undistorted output of 500mV, into 15 ohms. Sensitivity —0.5mV. Power gain 80dB. Frequency response 50 c/s to 20 kc/s \pm 3dB. Size 2 1/2" x 1 1/2" x 2". Operating voltage 9V.

READY BUILT AND TESTED

59/6

Complete with operating instructions and applications data

SINCLAIR GUARANTEED TRANSISTORS

MAT 100	High gain low level	7/9
MAT 101	Extra high gain, low level	8/6
MAT 120	High gain, medium and high level	7/9
MAT 121	Extra high gain, medium and high level	8/6
ADT 140	For FM, TV, VHF and UHF	15/-

To SINCLAIR RADIONICS LTD., 69 HISTON ROAD CAMBRIDGE

Please send

for which I enclose £.....s.....d.

NAME

ADDRESS

B RC.4

UNIQUE SINCLAIR GUARANTEE

Whatever you buy from Sinclair Radionics is sold to you on a complete satisfaction or money refunded guarantee subject to goods being returned as received. FULL SERVICE FACILITIES AVAILABLE TO ALL SINCLAIR CUSTOMERS.

SINCLAIR MICRO-6—SEE PREVIOUS PAGES

SINCLAIR RADIONICS LTD

69 HISTON ROAD, CAMBRIDGE

If you do not wish to cut out the coupon, please quote RC.4 when ordering

LATEST HIGH QUALITY COMPONENTS FROM THE MAXI-Q RANGE . . .

TESTED AND TRIED OVER 5 FREQUENCY RANGES

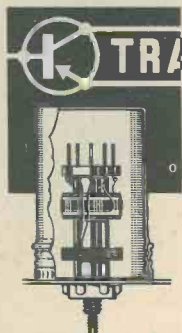

TRANSISTOR TUNING COILS

Coils for transistor superhets or converters, with or without an R.F. stage and using 465 kc/s or 1.6 Mc/s I.F.

- ★ Noval B9A Based for Plug-in application—Screw threaded for Chassis application.
- ★ Formers moulded in low-loss polystyrene for best results.
- ★ Each coil is packed in an aluminium container which may be used as a screening can.
- ★ Brass threaded adjustable iron-dust cores.

The following colour code identifies the coils:

BLUE—Aerial coil with base input winding.

YELLOW—Interstage R.F. coil with couplings.

RED—Oscillator coil for 465 kc/s I.F.

WHITE—Oscillator coil for 1.6 Mc/s I.F.

PRICE 4/9 each.

Coverages: Range 1T—15/4 Mc/s; 2T—515/1.545 Mc/s; 3T—1.67/5.3 Mc/s; 4T—5/15 Mc/s; 5T—10.5/31.5 Mc/s.

Full technical details now included in Technical Bulletin DTB.4—1/6d.

I.F.T.13 Miniature 465 kc/s I.F. Transformer . . . 7/6d. each

I.F.T.14 Miniature 465 kc/s Last I.F. Transformer 7/6d. each

I.F.T.16 Miniature 1.6 Mc/s I.F. Transformer . . . 6/6d. each

I.F.T.17 Miniature 1.6 Mc/s Last I.F. Transformer 6/6d. each

GENERAL CATALOGUE covering full range of components send 1/6d. in stamps.

PLEASE SEND S.A.E. WITH ALL OTHER ENQUIRIES.

DENCO (CLACTON) LTD (DEPT. R.C.) 357/9 Old Road Clacton-on-Sea Essex

MARTIN

10w HI-FI ASSEMBLY

Easily built with MARTIN
ALL-TRANSISTOR AUDIOKITS using
UNITS 1, 4, 5 and 6

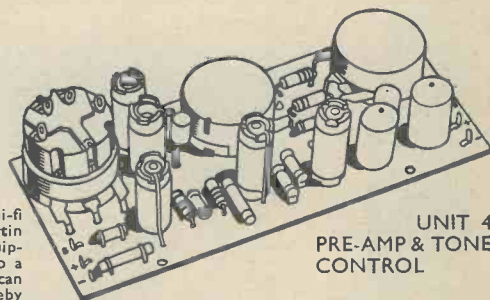

UNIT 4
PRE-AMP & TONE
CONTROL

With these kits, you can build a transistorised hi-fi assembly and then enlarge it by adding further Martin Audiokits. At the same time, you go on using the equipment with which you started. Should you change to a quite different type of pick-up, for example, you can match your existing Audiokit to it instantly and thereby save pounds. If you choose to convert to stereo, you can double the entire system quite simply whilst retaining much of the original material. Connections are standardised throughout, using printed circuit boards for which front escutcheon plates are available according to the combination of units selected. Kits are complete down to the last detail and include modern style knobs, full instructions, etc. Attractive escutcheon plates available to suit your kit arrangement, 10/6 each.

"FORMULA 1456" gives you a complete 10 watt hi-fi transistor assembly with 5-stage input selector; pre-amp; bass, treble and volume controls; A.C. mains power supply unit and, of course, the 10 watt amplifier, all for only £13.15.0.

- UNIT 1 5 stage matching input selector . . . £2. 7.6.
- UNIT 2 Pre-amp and master volume control £1.17.6.
- UNIT 3 3-Channel mixer . . . £3.19.6.
- Plug-in adaptors for same, each 8.6.
- UNIT 4 Combined pre-amp and tone controls £3. 2.6.
- UNIT 5 10 watt amplifier . . . £5.12.6.
- UNIT 6 Mains power supply unit . . . £2.12.6.

FOR TAPE ENTHUSIASTS

MARTIN RECORDA-KITS enable you to build a complete quality recorder or pre-amp for use between deck and hi-fi installation. These kits have won untinted praise in the technical press for their value, design and efficiency.

TRADE ENQUIRIES INVITED

MARTIN ELECTRONICS LTD 154-155 HIGH STREET, BRENTFORD, MIDDLESEX
Telephone ISL 5885/1161

MARTIN ELECTRONICS

Details of your Audiokits please

Details of your Recordakits please

Name _____

Address _____

RC.4 _____

HOME RADIO of MITCHAM

Dept. RC, 187 London Road, Mitcham, Surrey. Phone: MIT 3282

This is a page from our Catalogue.
If you think that the other
199 pages would interest
you, send Coupon
below, with 4/- P.O.

HOME RADIO LTD.
AERIAL ACCESSORIES

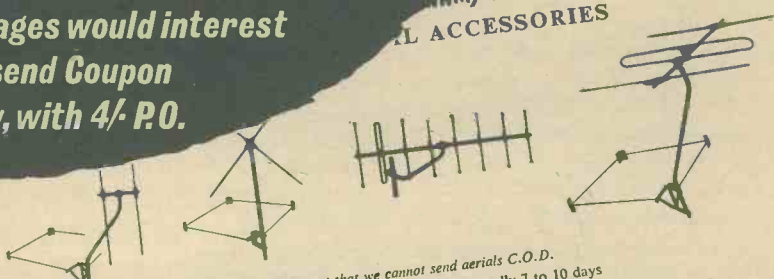

We regret that we cannot send aerials C.O.D.
* Obtainable to order only. Delivery usually 7 to 10 days
NOTE: WHEN ORDERING T.V. AND F.M. AERIALS PLEASE STATE CHANNEL REQUIRED

B.B.C. Band 1			Description	Price	
Car. No.	Maker	No. or Type		£	s. d.
*A6	Ant.	110/2B	Outside wall dipole	1	12 6
*A7	Ant.	110/9C	Outside dipole with chimney lashing	2	13 6
A8	Ant.	1X2/4E	Outside "X" with chimney lashing	3	15 0
*A9	Ant.	120/9M	Outside "H" with chimney lashing	4	3 6
I.T.A. Band 3			Loft mounting 3-element	1	19 6
A16	Wai.	LY3	Loft mounting 5-element	2	10 0
A17	Wai.	LY5	Outside 5-element aerial with stand-off arm and universal mast clamp	2	2 0 0
A19	Ant.	354/1C	As A19 but 3-element	3	5 0 0
A19A	Ant.	330/1C or 334/1C	Outside 5-element with stand-off arm for wall mounting.	2	17 0 0
A20	Ant.	354/2C	As A20 but 3-element	3	5 0 0
*A20A	Ant.	334/2C	Outside 5-element with chimney lashing	4	2 6
*A21	Ant.	354/9D	As A21 but 3-element	3	5 0 0
*A21A	Ant.	334/9D	Outside 8-element with stand-off arm and universal mast clamp	4	2 6
A22	Ant.	384/1C	Outside 8-element with chimney lashing		
*A23	Ant.	384/9D			

B.B.C. Band 4

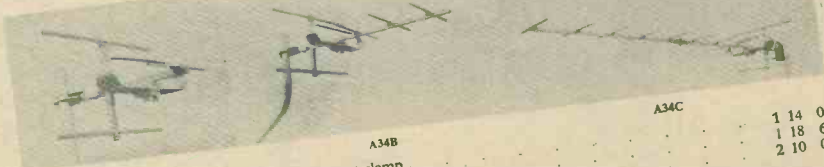

A34A	B.L.	3/4A	3-element with mast clamp	1	14 0
A34B	B.L.	5/4A	5-element with mast clamp	1	18 6
A34C	B.L.	10/4A	10-element with mast clamp	2	10 0
All the above					
F.M./V.H.F. Band 2			Loft adjustable dipole		
A26	Wai.	FML	Loft "H"		
A27	Wai.	FML/H	Loft 3-element		
A28	Wai.	FML/3A	Outside dipole wall m		
A29	Ant.	214/2B			
A30	Ant.	210/1A or 214/1A	Outside dipole with s		
*A31	Ant.	214/9C	Outside dipole with c		
A32	Ant.	224	Outside "H" with c		
*A33	Ant.	224/9M	Outside "H" with c		
*A34	Ant.	234/9M	Outside 3-element v		

Please write your name and address in block capitals

NAME

ADDRESS

HOME RADIO LTD., DEPT. RC, 187 LONDON ROAD, MITCHAM.

THE Radio Constructor



Incorporating THE RADIO AMATEUR

APRIL 1964

Vol. 17, No. 9
Published Monthly
(1st of month)

*Editorial and
Advertising Offices*
57 MAIDA VALE LONDON W9

Telephone
CUNningham 6141
(2 lines)

Telegrams
Databux, London

First Published
1947

Model Control Pocket Wavemeter-Monitor, <i>by F. G. Rayer, Assoc.Brit.I.R.E.</i>	588
Can Anyone Help?	589
Suggested Circuits No. 161: Tone-Operated Switching Circuit, <i>by G. A. French</i>	590
News and Comment	593
Simplicity and Sensitivity with Two Transistors, <i>by Sir Douglas Hall, K.C.M.G., B.A. (Oxon.)</i>	594
Book Review	595
Understanding Radio, Part 31, <i>by W. G. Morley</i>	596
Electronic "Watch Dog", <i>by R. M. Quail</i>	601
In Your Workshop	603
Three to One, Transistor Medium and Long Wave Tuner Unit, <i>by A. S. Carpenter, A.M.I.P.R.E.</i>	608
Christmas Castaway Contest—Results and Prize-winning Entry	612
3-Transistor VHF Receiver, <i>by D. M. Bussell</i>	614
Transistorised Vibrato Unit, <i>by Peter A. Roe, Grad.I.E.E.</i>	618
Transistorised Home Built Closed Circuit TV, Part 4, <i>by R. Murray-Shelley and T. Ian Mitchell</i>	625
Use of Tool Clips in Constructional Radio Work, <i>by E. Lawrence</i>	628
An Interchangeable Oscilloscope, Part 3, <i>by J. Hillman</i>	630
Transistorised Television Circuits, Part 6, <i>by Gordon J. King, Assoc.Brit.I.R.E., M.T.S., M.I.P.R.E.</i>	635
Radio Topics, <i>by Recorder</i>	639

© Data Publications Ltd., 1964. Contents may only be reproduced after obtaining prior permission from the Editor. Short abstracts or references are allowable provided acknowledgement of source is given.

Annual Subscription 30s. (U.S.A. and Canada \$4.50) including postage. Remittances should be made payable to "Data Publications Ltd". Overseas readers please pay by cheque or International Money Order.

MODEL CONTROL

Pocket Wavemeter-Monitor

By F. G. Rayer, Assoc. Brit. I.R.E.

THE UNIT DESCRIBED HERE IS BUILT INTO A SEALED glass tube and can be used as a wavemeter, with bulb indicator, and listening device to check transmitter modulation tones on the 27 Mc/s model control band. It can be easily carried in the pocket, and is thus always available for use when operating a model or transmitter.

Monitor Circuit

The monitor circuit is shown in Fig. 1. L_1 is tuned to the Model Control band by means of the 30pF concentric trimmer C_1 . L_2 is tightly coupled to L_1 , and provides current to light the 6V 0.06A indicator lamp. Part of the voltage available is rectified by the diode, to give an audio output for the miniature earpiece.

L_1 consists of 13 turns of 18 s.w.g. enamelled wire, approximately 15mm inside diameter. The exact diameter can be adjusted to suit the test tube used. Turns are wound closely side by side, after having straightened the wire by pulling it taut. An object is chosen (on which to wind the coil) having a diameter such that the finished coil pushes readily into the tube. The outer lead-out wire is brought up inside the coil, and both ends are arranged to reach the trimmer tags. The long central trimmer tag is cut off to clear the lamp.

L_2 is 2 turns of 20 s.w.g., or similar, plastic insulated bell wire. After winding the turns, the loop is taken over the trimmer and its ends are bared and shaped to meet the lamp, which is then soldered on.

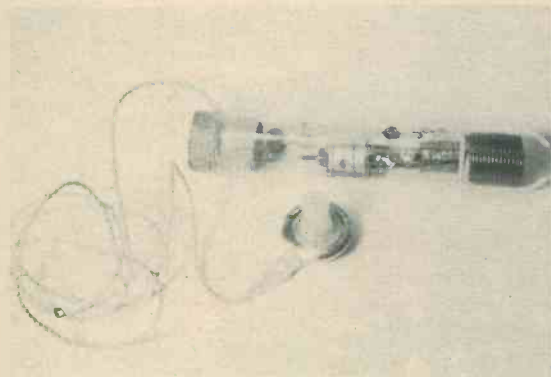

The completed unit

Resonance should be checked by holding the coil near a tuned transmitter. The trimmer is rotated until the lamp lights at greatest brilliance. If L_1 is of different dimensions than given, the number of turns can be adjusted, if necessary. If the trimmer has to be unscrewed very far, a turn or two should be removed from L_1 . If, on the other hand, the trimmer has to be screwed very far down, another turn or so may be needed on L_1 .

The diode and 1000pF capacitor, C_2 , are added as in Fig. 2. Insulated sleeving is placed on all leads. Wires should be clear of each other, and also clear of the trimmer. The whole assembly can then be inserted temporarily in the tube. A check of tuning should be made, to assure there is no difficulty in reaching 27 Mc/s.

The assembly is next removed, and coils L_1 and L_2 are cemented together. Rigidity is gained by cementing the lamp to the bottom of the trimmer. Coils and leads are also smeared with cement, and the whole is pushed into the tube and left until the cement has hardened.¹ Movement of parts after final tuning will upset the wavemeter calibration.

Tuning and Monitoring

A medium impedance personal phone is used for

¹ The cement used should have good dielectric properties. Polystyrene dope would be satisfactory.—EDITOR.

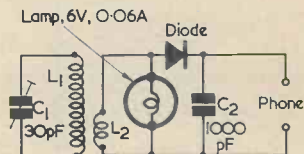

Fig. 1. The circuit of the monitor

Components List

Capacitors

- C_1 30pF, concentric trimmer
- C_2 1,000pF, ceramic

Inductors

- L_1, L_2 See text

Miscellaneous

- 1 germanium diode
- 1 6V 0.06A m.e.s. bulb
- 1 personal phone, see text
- 1 test tube, 4 x 3/4 in, with cork

listening, the thin flexible leads being soldered to the wires near the cork.² For use with a c.w. transmitter only, the diode, C₂ and phone may be omitted.

The monitor should be brought near the tank coil of a transmitter tuned to the middle of the 27 Mc/s Model Control band, and the trimmer very carefully adjusted, with a length of tube or rod made of insulating material, for resonance. For final adjustment, hold the monitor at such a distance that the lamp only just glows with the trimmer tuned correctly. The cork is then inserted, and a final check made.

To adjust a tunable transmitter, hold the monitor near the tank coil and tune the transmitter for maximum brilliance on the monitor lamp. Keep the monitor at a slight distance so that the exact tuning point is most readily seen. Both modulated and c.w. transmitters can be checked in this way.

To check that a modulated transmitter is radiating the correct audio tones, use the earphone and bring the monitor near enough to the transmitter tank

² An impedance around 2kΩ (corresponding to a d.c. resistance of approximately 500Ω for the average personal phone) should be satisfactory here—EDITOR.

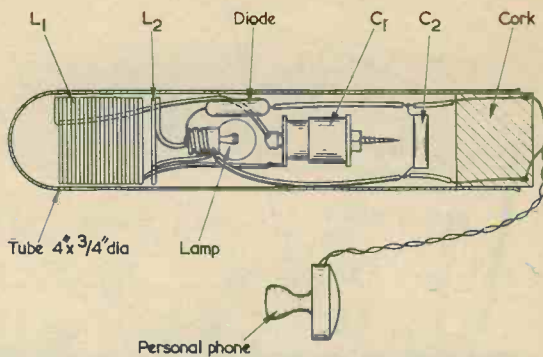

Fig. 2. The layout of components inside the glass test tube

coil to obtain sufficient volume.

With some transmitters, it may be inconvenient to reach the tank coil. If so, a coil of about 2 turns can be arranged in the aerial lead, and the monitor may be brought near this.

CAN ANYONE HELP?

Requests for information are inserted in this feature free of charge, subject to space being available. Users of this service undertake to acknowledge all letters, etc., received and to reimburse all reasonable expenses incurred by correspondents. Circuits, manuals, service sheets, etc., lent by readers must be returned in good condition within a reasonable period of time.

Wireless Set No. 31.—J. Allan, 35 Damask House, Flower House Estate, London, S.E.6, requires circuit or any data on this 18 valve equipment.

* * *

Bendix BC624A.—P. W. Dudson, 1 Raydon Street, London, N.19, would like to buy or borrow the circuit diagram.

* * *

Romac Radio Corp. TV Set Model No. 179/T.—J. McGrail, 494 Rochester Way, Sidcup, Kent, wishes to borrow or buy circuit or manual of this set.

* * *

R308 VHF Receiver.—B. Davies, 11 Hayes Crescent, North Cheam, Sutton, Surrey, wants to buy or borrow manual or circuit.

* * *

B44 Mk. II Tx/Rx.—A. E. Harvey, 39 Curliu Road, Oakdale, Poole, Dorset, requires the circuit diagram, i.f. frequency, or any other details applicable to amateur use.

* * *

CR100 Receiver.—W. Edmondson, 13 Lindfield Gardens, London, N.W.3, requires circuit or manual.

“Dromatic” Frequency Controlled FM Tuner.—E. C. Wright, 59 Thanet Road, Ipswich, Suffolk, requires information on the aerial, oscillator, i.f. and discriminator and associated components of the a.f.c. circuit.

* * *

MCR1 Receiver.—L. O. Tully, 120 Victoria Street, Fairfield S3, Brisbane, Queensland, Australia, would like to know if the reader who answered his previous appeal has forwarded the MCR1 coils and if so, would he write again.

* * *

R107.—D. J. Clampin, 73 Thorogood Road, Clacton-on-Sea, Essex, would like to purchase or borrow the manual for this receiver.

* * *

Beam Echo Stereo Pre-amp SP21/2.—J. Broughton, 10 Lodge Grove, Yateley, Camberley, Surrey, wishes to purchase or borrow the manual.

* * *

Weston Valve Tester/Multi-range Meter.—R. Hicklin, 13 Clive Road, Heath Park, Romford, Essex, has acquired this American instrument, Model No. 774/4, 774/5 or 744/4? Manual or any information most welcome.

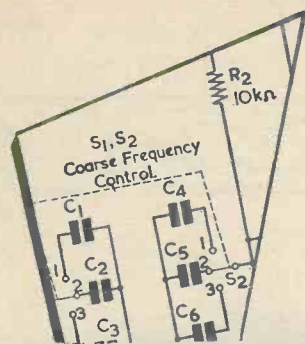

The circuits presented in this series have been designed by G. A. French, specially for the enthusiast who needs only the circuit and essential data

suggested circuits



No. 161 Tone-Operated Switching Circuit

ONE OF THE MORE FASCINATING aspects of experimental electronics is that it is possible to take advantage of component configurations which, whilst employing inexpensive standard parts, offer unusual performances that are peculiarly their own. A typical example is given by the parallel-T network shown in Fig. 1. Provided that the output is unloaded, this network can offer infinite attenuation at a single frequency when $R_1 = R_2 = 2R_3$ and $C_1 = C_2 = \frac{1}{2}C_3$.

Under these conditions, the frequency at which infinite attenuation occurs is given by $f = \frac{1}{2\pi R_1 C_1}$ where f is the frequency in cycles

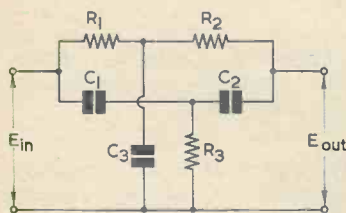

$$R_1 = R_2 = 2R_3$$

$$C_1 = C_2 = \frac{1}{2}C_3$$

$$f = \frac{1}{2\pi R_1 C_1}$$

Fig. 1. The parallel-T network

per second, R_1 is the resistance in ohms, and C_1 the capacitance in farads. (Alternatively, R_1 may be in megohms and C_1 in microfarads.)

This attribute of the parallel-T network is not of great use in conventional radio work, but it has several applications in test equipment. For instance, a distortion measuring instrument could employ a parallel-T network to completely filter out one frequency from the output of an a.f. amplifier. If a purely sinusoidal tone at that frequency is fed to the input of the amplifier, any harmonics introduced due to distortion in the amplifier will then appear, without the fundamental, after the parallel-T network. The level of such harmonics can be measured, whereupon the distortion introduced by the amplifier may be determined.

In this month's circuit, a parallel-T network is employed in a feedback loop to control the gain of an amplifying valve. At the frequency at which attenuation is infinite, feedback falls to zero and the valve is capable of providing full amplification, but at other frequencies the valve suffers a high level of feedback and its gain is considerably reduced in consequence. By coupling a microphone to the valve, together with a circuit capable of actuating a relay, it becomes possible to switch on an external circuit whenever a sound at the attenuation frequency is picked

up by the microphone. Sounds at other frequencies do not cause the external circuit to be switched on.

The use of a parallel-T network in this manner is not new, and a recent instance appeared in the Danish magazine *Radio Og Fjernsyn*.*

The Circuit

The circuit of the tone-operated switching device appears in Fig. 2. In this diagram a crystal microphone, in parallel with R_1 , is coupled to the grid of $V_{1(a)}$ via R_2 . $V_{1(a)}$ is one half of a 12AX7 and its anode connects to a parallel-T network by way of C_4 . The parallel-T network is given by R_3 , R_4 , R_5 , C_1 , C_2 and C_3 , and it couples back to the grid of the valve. It will be noted that R_5 has half the value of R_3 and R_4 , and that C_3 has twice the value of C_1 and C_2 . These are the relationships required in the parallel-T network. The values shown in Fig. 2 for the network were chosen arbitrarily to give an attenuation frequency in the audio range, the actual frequency being 1.3 kc/s. Alternative attenuation frequencies may be obtained by adjusting the values in the network in accordance with the equation given above.

The anode of $V_{1(a)}$ also couples, via C_5 , to the grid of $V_{1(b)}$. $V_{1(b)}$

* O. Baden, "Selektiv Tonerelae", *Radio Og Fjernsyn*, May 1963.

functions as a conventional a.f. amplifier, and its anode feeds into the shunt detector, D_1 . Diode D_1 is so connected that a positive rectified voltage, proportional to the level of the a.f. signal fed to it, is passed to the low-pass filter $R_{11} C_8$. This positive voltage is then applied to the grids of $V_{2(a)}$ and $V_{2(b)}$.

V_2 is a 12AT7, this valve being chosen because of its short grid base. In the circuit, the two triodes of the valve are connected in parallel. The two cathodes are held at about cut-off level by the zener diode D_2 , this maintaining the cathodes approximately 6 volts positive of chassis irrespective of anode current. In the absence of anode current, D_2 is held at its zener voltage by resistor R_{12} . The anodes of the 12AT7 couple to the h.t. line via a relay coil having a resistance of $10k\Omega$. It is assumed that the relay is capable of energising at some 10mA, whereupon its normally-open contacts may complete an external circuit.

When sound at frequencies other than the attenuation frequency is picked up by the microphone, the parallel-T network between the anode and grid of $V_{1(a)}$ causes this valve to offer very little gain. In consequence, only a very low level of a.f. is passed to $V_{1(b)}$ and to the following shunt detector. A small positive voltage may appear across diode D_1 , but this is too low to allow V_2 to pass any significant increase in anode current. On the other hand, when sound at the attenuation frequency is picked up by the microphone there is zero feedback from the anode to the grid of $V_{1(a)}$, and this valve offers the full amplification of which it is capable. In consequence, a high level of a.f. is passed to $V_{1(b)}$ and a high positive voltage is applied to the grids of V_2 . The anode current of V_2 increases to 10mA or more, whereupon the relay energises and the external circuit is switched on.

Results with the Prototype

In order to judge the effectiveness of the circuit, a prototype was made and checked out. The microphone employed was an Acos model type MIC40. The circuit was tested by the simple process of whistling at a distance of several feet from the microphone, and observing the resulting relay current.

With the particular 12AT7 and zener diode employed in the D_2 position there was, in the absence of signal, a relay current of about 0.4mA. Whistling at frequencies far removed from the attenuation frequency caused no perceptible increase in relay current. At frequencies

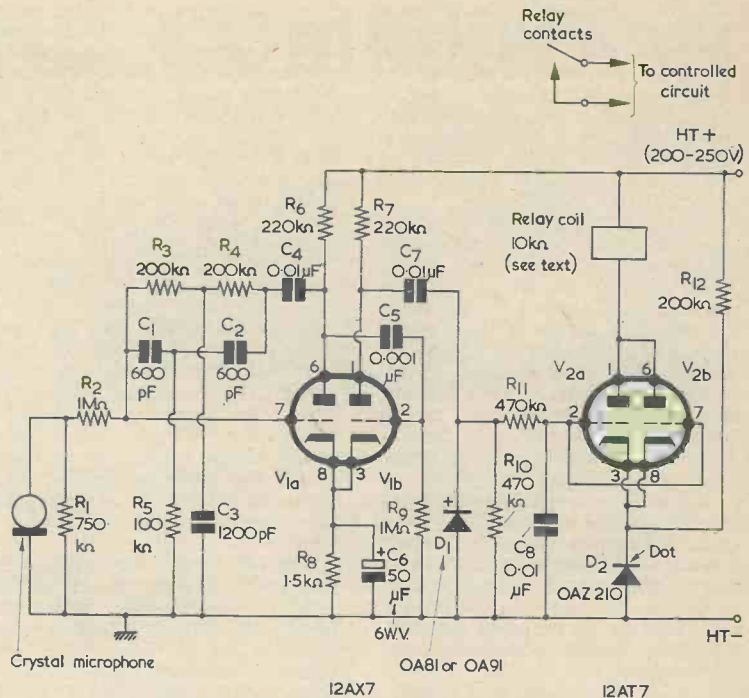

Fig. 2. Complete circuit of the tone-operated switching unit. This device causes the relay to energise for sound at 1.3 kc/s, and it may be made to operate at other frequencies by adjusting the values in the parallel-T feedback network between the anode and grid of $V_{1(a)}$

close to the attenuation frequency, relay current increased by 1mA or so and, at the attenuation frequency itself, it rose to well in excess of 10mA. The range of frequencies over which relay current was in excess of 10mA was very small; so small, indeed, that it was difficult to maintain the frequency sufficiently steady for more than short periods of time.

Relay current did not increase perceptibly with loud transient noises, or when the microphone was tapped. Also, loud speech at a distance of a foot did not cause any increase in relay current. Loud speech with the microphone held in contact with the lips could, however, cause the relay to operate.

From these checks it would appear that the circuit is capable of actuating an external circuit only when sound at a particular frequency impinges on the microphone, provided that the instance does not arise where the sound input could be of the same high order as occurred in the last test. A desirable method of providing the actuating frequency would be offered by using an actual whistle instead of by attempting to whistle

with the lips. When blown, such a whistle will have its own distinctive fixed frequency, and the components in the parallel-T filter can be adjusted in value to suit that frequency. It is worth noting that, provided a suitable microphone is employed, the whistle could be of the supersonic type. Other methods of operation may also suggest themselves to the experimenter.

Circuit Details

There are a number of circuit details which need a little further discussion, and these may now be dealt with.

It will be noted that the two cathodes of $V_{1(a)}$ and $V_{1(b)}$ are connected to a common bias resistor and capacitor. This method of connection functions satisfactorily in practice when it is not intended to provide amplification of the lower audio frequencies, and it results in a saving of components. To ensure attenuation of the lower audio frequencies, C_5 is given the somewhat low value of $0.001\mu F$.

Hum is liable to be a little troublesome when the two sections of a high-gain double-triode such as the

12AX7 are employed in cascade, and its effect is reduced somewhat by the low value of C_5 . Nevertheless, it would be advisable to keep all the components in the grid circuit of $V_{1(a)}$, including the parallel-T network, well clear of heater wiring. If the microphone is not mounted on the chassis it should be connected to it by way of screened cable.

Since it is unlikely that the crystal microphone will be expected to offer full output at frequencies below some 200 c/s or so, it becomes permissible to connect a lower value of resistance across it than would appear in conventional a.f. amplifier design. The value specified for R_1 in Fig. 2 will result in low frequency attenuation with normal crystal microphones. At the same time, it helps to reduce hum pick-up in the grid circuit of $V_{1(a)}$.

It is possible that high a.f. voltages may be applied to diode D_1 , whereupon it becomes desirable to select a diode for this position which has a high peak inverse voltage rating. Both the OA81 and the OA91 have p.i.v. ratings of 115 volts at 25°C, and either would be perfectly satisfactory here.

Due to spread in the characteristics of both the zener diode (D_2) and the 12AT7 (V_2) it is possible that, under no-signal conditions, the 12AT7 may

be either beyond cut-off or further within cut-off than occurred with the writer's prototype. If this is considered important, the situation may be partly eased by employing the more expensive OAZ203 instead of the OAZ210 specified. Both diodes have a nominal zener voltage of 6.2 at 1mA, but the OAZ203 has a tolerance on zener voltage of $\pm 5\%$ only, as compared with a $\pm 15\%$ tolerance in the OAZ210.

The relay employed should have a coil resistance of $10k\Omega$. This limits the maximum current flowing through the 12AT7 and the zener diode to some 20mA, with the result that zener diode dissipation is well within the maximum permissible figure for operation without a cooling clip. If a relay with a lower coil resistance is used, the resistance should be made up to the $10k\Omega$ figure by means of an additional series resistor.

Apart from the components in the parallel-T network, none of the resistor or capacitor values are particularly critical. Resistor tolerances could all be $\pm 20\%$, and capacitor tolerances those associated with paper components. In the parallel-T network itself, it would probably be preferable to work to component tolerances of $\pm 5\%$.

As it stands, the circuit responds

almost immediately when sound at the attenuation frequency is picked up by the microphone. If desired, the speed at which the relay energises (and de-energises after cessation of the sound) may be increased by increasing the value of C_8 . This capacitor should not, on the other hand, be decreased in value by any large amount, as there would then be a risk of a.f. appearing at the grids of V_2 . As there is no h.t. decoupling, this could result in instability or erratic operation.

A final point has to do with the range of volume levels over which the circuit is effective. As was shown by the results obtained with the prototype, the circuit can be made to operate when a very high signal level which is not at attenuation frequency appears across the microphone. This is due to the fact that the parallel-T filter does not offer the very wide range of discrimination (between a low level of attenuation and infinite attenuation) of which it would be capable if it appeared, say, between two amplifying stages. In the present circuit, the parallel-T network allows $V_{1(a)}$ to amplify at full gain at the attenuation frequency, and at very much reduced gain at other frequencies. With the component values shown in Fig. 2, discrimination will probably be in excess of 35 times, or 31dB.

Six New Marconi TV Stations for I.T.A.

Another contract to supply and install six completely new television stations has been awarded to The Marconi Company by the Independent Television Authority. These stations, which have been designed for unattended operation, will provide full television coverage for areas not already catered for by existing transmitters in a relatively simple and economical way.

Marconi's will now have supplied the complete transmitting equipment for twenty of the twenty-nine I.T.A. transmitting stations in addition to part of the equipment for a twenty-first station.

The six sites will be split into two groups. Installations at Caithness, Central Berkshire and Bedford will have four Marconi translators, Type BD.368, four 500W amplifiers, Type BD.377, plus all the associated feeder and ancillary equipment. The other three, to be installed at Dundee, Scarborough and the Isle of Man, will be equipped with dual translators and dual 500W amplifiers with the associated ancillary equipment.

Due to topographical conditions, it is inevitable that in many areas covered by national or regional services, there will be places where the signal strength is insufficient for normal domestic receivers. This Marconi translator equipment has been designed especially to provide a television service in areas such as these.

NEWS AND COMMENT . .

Resale Price Maintenance

The Resale Prices Bill is certainly proving to be a controversial measure and it is difficult to assess whether its provisions will benefit the consumer in the long run.

Radio constructors are used to "shopping around" for components and government surplus equipment and the effect of the abolition of price maintenance would probably only be noticed by our readers where new equipment was concerned. At first sight it would seem very attractive to purchase a TV receiver at below the manufacturer's list price, but there are snags. If a retailer, or a manufacturer for that matter, has cut his margin of profit too drastically he must make his profit elsewhere if he is to remain in business, this might affect after sales service for instance.

The rules of the Radio & Television Retailers Association very wisely concern themselves with seeing that their members are all treated alike under the law as it stands.

The Association lists 8 specific actions which they consider are improper evasions of price maintenance. Some of them are the offering of cash discounts; gifts; aeriels, replacement tubes, valves and components supplied without charge beyond the manufacturer's guarantee period; free insurance; inflated exchange values on part exchange, etc.

The foregoing indicates the difficulties in enforcing price maintenance. In the long run however, too much should not be expected from its probable abolition. Both manufacturers and retailers must make reasonable profits to remain in business. The fear is that in a price cutting war quality and services will suffer and that many smaller concerns will go the wall which, in the long run, may mean less variety of choice for the consumer. Also, no doubt, there will be those who mark up prices in order to knock them down again to give an apparent "bargain", and the like. Ending resale price maintenance is not the simple benefit it might appear and this fact is recognised in the Bill; clause 5 confers jurisdiction on the Restrictive Practices Court to order that particular classes of goods should be exempted goods.

R.S.G.B.

Mr. John A. Rouse has been appointed General Manager and

Secretary to the Radio Society of Great Britain, in succession to the former General Secretary, Mr. John Clarricoats, O.B.E.

Mr. Clarricoats gave yeoman service to the Society for a period of no less than 37 years. This remarkable record was recognised by members of the Society at presentations made to Mr. Clarricoats of high class radio equipment and other items, including a cheque for £456, all subscribed by members and friends. Mr. Clarricoats has been elected the first Honorary Member of the Society.

New Ten-pin Valve Simplifies TV Set Design

A significant advance in valve construction is achieved in the latest Mullard valve to be supplied to television set manufacturers. The new valve type PFL200 is housed in a B9A sized envelope yet uses a ten-pin (decal) base. The base has the same pitch-circle diameter as the familiar B9A base.

The "decal" (B10B) base enables two completely separate pentode systems to be incorporated in one envelope. In the PFL200 one pentode system is intended for use as a high-gain video output stage, the other as a medium-slope voltage amplifier in, for example, sync separators or a.g.c. stages. By giving the two sections complementary electrical characteristics it is possible to simplify and hence reduce the cost of receiver circuitry.

Particular care has been taken in the pinning and in the screening between the two sections of the valve to provide independence of operation.

Output Section

The PFL200 "L" section is designed to operate as a high-gain video output stage capable of producing a large output voltage across a low value anode load resistor. This is particularly useful in switchable receivers operating on the new 625-line standard which require twice the bandwidth of the 405-line standard. To achieve high gain and thus allow the application of negative feedback, a frame-grid control grid has been used, and this gives the valve a slope of 21mA/V at 30mA.

Amplifier Section

The "F" section of the PFL200 is a voltage-amplifying medium-slope

pentode and in receivers for the British market it is most likely to find applications as a sync separator. The valve has thus been designed to provide adequate current at a low anode voltage. In receivers intended for overseas markets where sync separation is usually effected by an interference-gated heptode circuit, the "F" section of the PFL200 can be employed with advantage as a high gain a.g.c. amplifier or as an intercarrier sound i.f. amplifier.

Grant for Computer Control of Printing

Following upon our remarks last month on the forecast of Instant Electronic Newspapers, has come the news of a grant of £28,650 by the Department of Scientific and Industrial Research, to London University to enable Dr. Michael P. Barnett to carry out research into the control of printing by computer. Unlike Instant Electronic Newspapers even the services of a compositor would not be required.

About half the grant will be used for the purchase of equipment including a photo-composing unit. Dr. Barnett is returning from the United States, where he is at present Director at the Co-operative Computing Laboratory of the Massachusetts Institute of Technology. ("Brain drain" in reverse?)

The application was considered at the first meeting of a new sub-committee of the Research Grants Committee of DSIR which has been set up under the chairmanship of Lord Halsbury to evaluate applications for grants to aid work on the computer sciences.

The research, which will form part of the programme of the University's Computer Unit, will be concerned with the application of a computer to the production of paper tape to control type-setting equipment or photographic printing processes.

Computer languages and programmes will be adapted to specify the format and editorial details needed to set up books and publications.

The London University Atlas Computer will be used to carry out the work, in conjunction with the S-561 photo-composing unit. This is the most suitable type-setting device at present available. It is relatively inexpensive and has the necessary flexibility for a wide variety of applications to be explored.

Simplicity and Sensitivity with Two Transistors

Sir Douglas Hall, K.C.M.G., B.A.(Oxon)

Reflex transistor receiver circuits are always of interest if only because they employ a single transistor which functions both as an r.f. and as an a.f. amplifier. In the design described in this article, an ingenious approach enables two transistors to carry out this dual function. Apart from the two transistors and the diode there are only ten components in the receiver circuit and, as the author points out, this is exactly twice the number of stages!

IN DESIGNING THIS CIRCUIT THE author aimed at great simplicity combined with sufficient sensitivity to guarantee reception of medium wave local stations on a personal earphone, using the smallest of ferrite aerials as the only means of pick-up. Two transistors are used, each wired as a reflex amplifier, and a crystal diode provides demodulation. Excluding the transistors and diode there are only ten components—and this is exactly twice the number of stages in the circuit!

The sensitivity is such that using a ferrite slab $1\frac{1}{2}$ in long, $\frac{1}{2}$ in wide and $\frac{1}{8}$ in thick, very considerable volume is delivered through a high impedance earphone of the deaf aid type from the local station. Also, and not quite so powerfully, a fair number of Continental stations can be picked up after dark. The prototype is contained in a plastic box available from Woolworth's stores for 1s., this measures $3\frac{1}{2} \times 2\frac{1}{2} \times 1\frac{1}{2}$ in. The case could be a good deal smaller, but the one used will take a No. 8 battery. Such a battery will give a phenomenal length of service as the total consumption is only 0.75mA.

Avoiding Instability

One of the difficulties in designing a double reflex circuit is to avoid

audio frequency instability. With two common emitter amplifiers in cascade the audio frequency signal at the collector of the second is in phase with the signal at the base of the first. But in a double reflex circuit it is necessary for there to be some coupling between these two points, since the amplified radio frequency signal is passed to the detector and then, as audio frequency to the base of the first transistor for further amplification by both transistors. True, the coupling to the detector is designed for radio frequencies and therefore offers a very high impedance for audio frequencies; but most constructors have experienced audio frequency instability arising merely through stray capacitances. Coupling does not have to be much more than nominal to produce unwanted positive feedback when high efficiency transistors are used.

This circuit used MAT101 transistors. These are of the micro-alloy type recently described in this journal,* and they are exceptionally efficient at all normal frequencies. If two of them were used in a conventional double reflex circuit in which the detector is fed from the collector

* Sinclair, C. M., "The Advantages of Micro-Alloy Transistors", *The Radio Constructor*, September 1962.

of TR₂, there would be hopeless audio frequency instability unless drastic steps were taken to reduce the maximum a.f. amplification available. But in this circuit the problem is overcome by using the second transistor as a common collector amplifier at radio frequencies, whilst it amplifies audio frequencies as a common emitter device. The first transistor is a common emitter amplifier at all frequencies.

The Circuit

If the circuit diagram is examined it will be seen that L₁ and VC₁ produce a capacitance-tapped tuned circuit, the tap (at positive supply line potential) being brought about by C₁ (in series with a small part of VR₁) and the base-emitter capacitance "seen" by the tuned circuit. Direct coupling from TR₁ to TR₂ is provided by way of R₂ and the radio frequencies are then further amplified by TR₂. But at radio frequencies the collector of TR₂ is at earth potential, owing to C₂, while the emitter is at high potential because of the choke L₂. The high frequency signal, which has now received two stages of amplification, is demodulated by D₁ and the low frequency signal resulting is then applied, through the tuned circuit, to the base of TR₁ for two further stages of amplification. At radio frequencies there has been a phase change of 180° through TR₁, but no further phase change through TR₂. A small part of the high frequency signal will be present at the output from D₁. This will have its phase changed again as a result of the capacitance tap in the tuned circuit, and will therefore find itself in phase with the original signal. Regeneration results. VR₁, in conjunction with C₁, regulates the amount of the radio frequency signal which can return to the tuned circuit and therefore acts as a reaction control.

It may appear from the circuit that D₁ has been connected the wrong way round, so that reaction will be spoilt by backlash as a result of TR₁ becoming more sensitive when the point of oscillation is approached. It is true that the base of TR₁ will become more negative in these circumstances and that, consequently, the amplification offered by this transistor will tend to rise. But this will also mean that more current passes through TR₁ with an increase in the voltage drop across R₂. The voltage drop will make the base of TR₂ more positive and hence reduce the amplification provided by TR₂. The effect of passing the critical reaction point is

Components List

Resistors

- VR₁ 5kΩ potentiometer, linear or semi-log track. See text.
 R₁ 470Ω ¼W 10%
 R₂ 6.8kΩ ¼W 10%

Capacitors

- VC₁ 500pF variable
 C₁ 100pF
 C₂ 1,000pF
 C₃ 100μF, electrolytic, 6V wkg

Inductors

- L₁ Subminiature medium wave ferrite slab aerial. See text (T.S.L.)
 L₂ 2.5mH r.f. choke, type CH1 (Repanco)

Semiconductors

- TR₁ MAT101
 TR₂ MAT101
 D₁ Germanium diode

Switches

- S₁ s.p.s.t. switch

Earphone

- Miniature personal phone, type ER1600 (Henry's Radio Ltd.)

Battery

- 3 volt. Dimensions to suit case

for TR₂ to oscillate, and not TR₁. Consequently the overall amplification is reduced as the base of TR₁ becomes more negative. These circumstances are suitable for smooth reaction, and this is borne out in practice. It will be found that the circuit can be held on the very threshold of oscillation with great sensitivity resulting. The "a.g.c." effect is most marked, fairly violent oscillation, deliberately brought about by advancing the reaction control too far, being stopped as soon as a local station is tuned in.

Any a.f. signal which finds itself across L₂ will be fed back to TR₁ out of phase, as the phase reversal brought about by the capacitance tap on the tuned circuit is clearly without effect at audio frequencies. There will, in fact, be a small amount of negative feedback since, although the inductive impedance of L₂ at audio frequencies is minute, there is a d.c. resistance of about 15Ω in the winding. This is small compared with the load in the collector circuit, and the practical effect is a very slight reduction in amplification accompanied by improved quality and complete stability.

Components

There is nothing very critical about the components, but it is important that the specified transistors be used. L₁ can be the main winding of any ferrite rod aerial. The one specified is very small and efficient, and it is easy to adjust the position of the winding so as to obtain the wave coverage which is wanted. The winding is fairly large

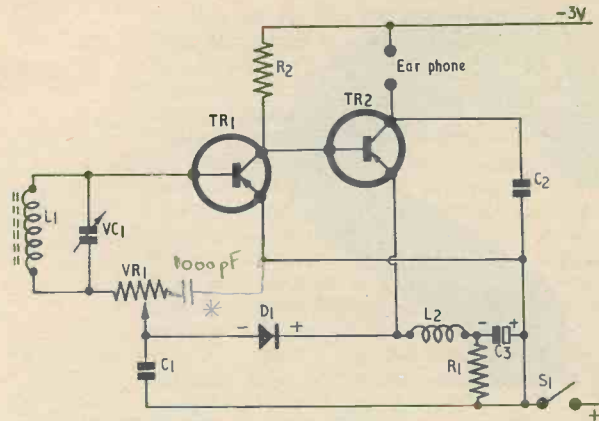

* SEE PAGE 41

and, in the prototype, it had to be slid partly off the ferrite slab in order to tune in the Third Programme on 194 metres.

VR₁ should be a linear control if possible, as this will prove much more satisfactory to use than one with log characteristics. But, if a miniature linear control is difficult to obtain, a semi-log type may be employed, such as the Arden VC 1545. The latter is very small and is complete with battery switch.

The earphone should be of the high impedance magnetic type. The prototype works best with a personal phone type ER1600 which has a specified impedance of 7kΩ and a d.c. resistance of 1,600Ω. This is obtainable from Henry's Radio Ltd., complete with jack and socket. A standard 1kΩ impedance phone, which usually has a d.c. resistance of about 100Ω will work, but sensitivity will be reduced. The d.c. resistance of the phone should not be greater than about 2kΩ, and ordinary 4kΩ headphones may not be found satisfactory.

book review . . .

RADIO AND ELECTRONIC HOBBIES. By F. C. Judd, A.Inst.E. 165 pages, 5½ x 8½ in. Published by Museum Press Ltd. Price 21s.

Mr. F. C. Judd is well known to regular readers of *The Radio Constructor*, and "Radio And Electronic Hobbies" represents the latest of his publications in book form. In this book, Mr. Judd has concentrated on including the widest possible range of constructional subjects with a minimum of theory. Included are the following subjects: radio receivers, audio amplifiers, transistor circuits, high fidelity and stereo, tape recording, electronic musical instruments, amateur radio transmitting, radio control, cathode ray tubes, aerials and test equipment. Also provided is a chapter devoted to suitable subjects for the school science classroom.

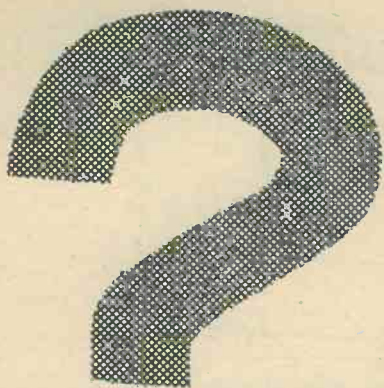

The thirty-first in a series of articles which, starting from first principals, describes the basic theory and practice of radio

part 31

understanding radio



By W. G. MORLEY

IN THE FEBRUARY ISSUE WE INTRODUCED THE subject of sound reproduction, examining the nature of sound and the manner in which it is perceived by the ear. We then briefly discussed the operation of the carbon microphone and showed how this, in company with an energising battery and transformer, could produce an alternating voltage which varied in amplitude and frequency with the compressions and rarefactions of the sound at its diaphragm. We shall now carry on to the earphone.

The Earphone

There are several types of *earphone*, or *headphone*, these differing from each other by reason of their basic method of operation. By far the most common type is that in which a diaphragm made of magnetic material is directly affected by a varying magnetic field, and it is this type which we shall consider at this stage. It is instructive to note that earphones employing the magnetic diaphragm principle have been in use for a considerable number of years, and that they appeared in telephone work as "receivers" long before the advent of radio reception.

In one of its more familiar forms, the magnetic diaphragm earphone has the construction shown in Figs. 195 (a) and (b). In this diagram, a permanent horseshoe magnet is coupled to a pair of pole pieces which carry its magnetic field close to a thin diaphragm made of springy magnetic material. The case of the earphone is non-magnetic and is so dimensioned that, whilst the diaphragm is under stress due to the magnetic field, a small clearance exists between its inside surface and the pole pieces. Fitted to the pole pieces are two coils connected in series. When a current is passed through these coils in one direction, the resulting magnetic field adds

to that offered by the permanent magnet. Conversely, when the current is passed through the coils in the opposite direction, the resulting magnetic field opposes that offered by the permanent magnet, and thereby reduces the effect of the latter on the diaphragm. In practice, the field due to the magnet is always considerably greater than the field due to the coils.

In the previous article we saw that we could obtain an electrical signal corresponding to a sound signal by means of a carbon microphone in conjunction with a battery and a transformer, and Fig. 196 shows the secondary of the microphone transformer (across which the signal appears) connected to the coils of the earphone.¹

When sound impinges on the microphone of Fig. 196, an alternating voltage is induced in the secondary of the transformer and a corresponding current is caused to flow in the coils of the earphone. This current varies in sympathy with the frequency and amplitude of the original sound and, according to its direction, alternately strengthens or weakens the magnetic field between the pole pieces and the diaphragm. The centre of the diaphragm then suffers greater or less attraction to the pole pieces and, in consequence, vibrates in sympathy with the microphone signal. The result is that the diaphragm reproduces the sound which is initially applied to the microphone.

The vibration of the earphone diaphragm due to the varying current in its coils results in air vibrations which are perfectly audible. However, the apparent loudness of the sound from the diaphragm becomes enhanced if a cap such as that illustrated in Fig. 197

¹ Fig. 196 also shows the circuit symbol which is generally employed to depict a microphone.

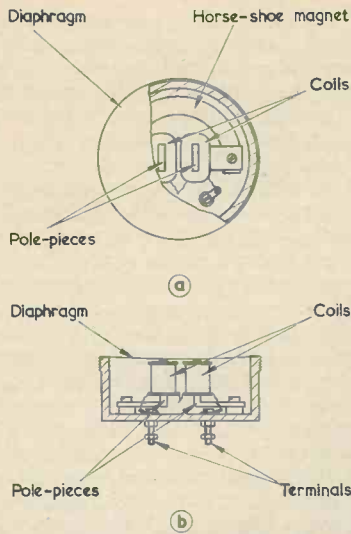

Fig. 195. The construction of a typical magnetic diaphragm earphone. The cap is not shown here. A top view is given in (a), wherein the diaphragm is partly cut away to show the internal components. A sectional view is given in (b).

is fitted. This cap causes a small chamber having a depth of approximately 0.04in to be formed in front of the diaphragm. The small volume of air in this chamber is then compressed and rarefied by the vibrating diaphragm, causing proportionally larger compressions and rarefactions to appear at the aperture in the centre of the cap. It should be noted that the chamber does not cause any actual increase in sound power, despite the fact that its presence results in an apparent increase in the loudness of the sound from the diaphragm. Its action may be likened to that of a transformer, in so far that it matches the "sound impedance" of the vibrating diaphragm more efficiently to the "sound impedance" of the outside air. This matching effect approaches an optimum when the earphone is held up against the ear, as it is, of course, intended to be.

In some earphones having the basic construction illustrated in Fig. 195, the cap may have several smaller holes at the centre, as shown in Fig. 198, instead of the single central aperture. The effect of the cap in providing a small acoustic chamber is, nevertheless, the same.

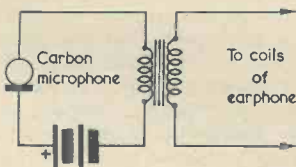

Fig. 196. Coupling a carbon microphone to the earphone

The Reason for the Permanent Magnet

An important feature of the earphone is given by the presence of the permanent magnet. It might be thought, at first sight, that a permanent magnet is not necessary, and that it would be possible to obtain a satisfactory audible sound from the diaphragm by reason of the varying current in the coils on its own. This assumption is, however, incorrect, and it is necessary to include the permanent magnet if correct operation is to be obtained. There are two reasons for this. The first, and more important, reason is that the permanent magnet imparts a considerable degree of sensitivity to the earphone. It can be shown that the force of attraction, or "pull", on the diaphragm due to the magnetic field at the pole pieces varies according to the square of the flux density, B^2 . This flux density is comprised of two components, one of these being due to the permanent magnet and the

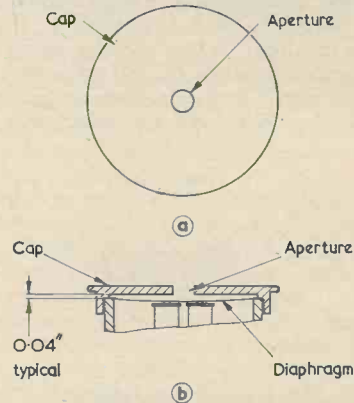

Fig. 197. To enhance the apparent loudness offered by the diaphragm, a cap is screwed on to the case, causing a small chamber to appear in front of the diaphragm. A top view of the cap is given in (a), whilst (b) shows the cap fitted to the earphone of Fig. 195 (b)

other due to the alternating current in the coils. Let us call the first flux density B_M and the second flux density B_C . When the flux density due to the coils assists that due to the magnet, the total flux density is $B_M + B_C$, whereupon the pull on the diaphragm becomes proportional to $(B_M + B_C)^2$. Similarly, when the flux density due to the coils is in opposition to that due to the permanent magnet, the pull on the diaphragm becomes proportional to $(B_M - B_C)^2$. If an alternating signal current flows in the coils, therefore, the pull on the diaphragm becomes proportional to $(B_M \pm B_C)^2$ or, if we remove the brackets and square the expression, to $B_M^2 \pm 2B_M B_C + B_C^2$.

If no signal current is applied to the coils, the pull on the diaphragm is proportional to B_M^2 because B_C is then equal to zero. It follows from this that the pull due to the signal current is proportional to $\pm 2B_M B_C + B_C^2$.

² Flux density was discussed in "Understanding Radio" part 22, June 1963 issue.

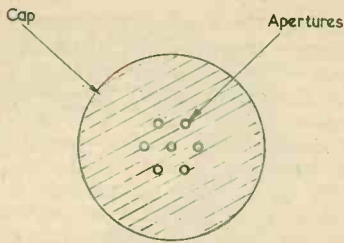

Fig. 198. Some earphone caps have a number of small apertures instead of the single central aperture shown in Fig. 197

Let us now see what happens if we dispense with the permanent magnet and rely on the flux density due to the coils on their own. As soon as we dispense with the magnet the flux density B_M becomes zero, whereupon the term $\pm 2B_M B_C$ similarly becomes zero. The diaphragm is, then, only affected by the flux density corresponding to B_C^2 . In practice, it is possible to make the flux density due to the magnet very many times greater than that due to the coils, with the result that the ex-

pression $\pm 2B_M B_C + B_C^2$ becomes considerably larger than B_C^2 on its own. Since, with the permanent magnet, the pull on the diaphragm is proportional to a much greater quantity than is given by the coils on their own, it follows that the permanent magnet imparts a very high degree of sensitivity to the earphone.

The second reason for the desirability of having a permanent magnet is that, without it, the diaphragm would vibrate at twice the frequency of the alternating current flowing in the coils. This point may be more readily appreciated if we initially examine the simple alternating current of Fig. 199 (a), assuming that this flows in the coils of an earphone which does not have a permanent magnet. If we start at point A in Fig. 199 (a) we have the instance when the current is at zero. In consequence, there is no magnetic field in the pole pieces and the diaphragm is at rest. As we proceed from point A to point B, the current increases, with the result that the diaphragm suffers increasing attraction towards the pole pieces. After point B the current decreases, whereupon the diaphragm suffers a decreasing attraction until, at point C, it is once more at rest. From point C to point D we have an increasing current in the reverse direction, but this change of direction is not perceived by the diaphragm, which once more suffers increasing attraction towards the pole pieces. From D to E the current decreases again, and the diaphragm once more returns to its state of rest.

In Fig. 199 (b) we assume that the alternating current is applied to an earphone fitted with a permanent magnet. We assume, also, that the half-cycle from A to C results in a flux density which assists that due to the permanent magnet. In consequence, the diaphragm suffers increasing attraction towards the pole pieces from points A to B, and decreasing attraction from points B to C. After point C, the flux density due to the alternating current opposes that from the magnet, and the diaphragm continues to suffer decreasing attraction until we reach point D. After point D, it starts to suffer increased attraction and this continues until point E. At point E the diaphragm is in the same condition as it was at point A.

It is obvious from an examination of Fig. 199 that, in (a), the diaphragm undergoes two cycles of movement for a single cycle of current, whereas, in (b), it undergoes only a single cycle of movement. In (a), therefore, the associated earphone will emit sound at twice the frequency of the alternating current whilst, in (b), it will emit sound at the same frequency. The state of affairs in (b) is, of course, preferable to that in (a).

It is interesting to note that the effect given in Fig. 199 (a) is that which would be indicated by the result of our investigation into the first reason for having a permanent magnet. Without the magnet, the pull on the diaphragm is proportional to B_C^2 . The square of both positive and negative quantities is always positive, and it follows that, without the permanent magnet, the pull on the diaphragm will always be in the same direction regardless of the

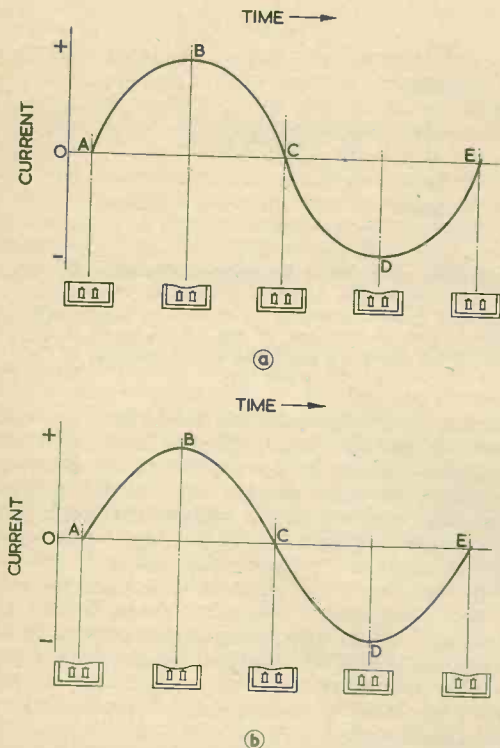

Fig. 199 (a). The effect given by applying an alternating voltage to an earphone without a permanent magnet. The displacements of the diaphragm are shown in exaggerated form. (b). A more correct effect is given when the earphone has a permanent magnet

direction of the current in the coils.

Another point which may now be raised is that we could, theoretically, dispense with the permanent magnet if we caused a direct current to flow through the coils in addition to the alternating current which corresponds to the sound signal. Provided that the direct current was always greater than the peak value of the alternating current, the earphone would then respond, correctly, in the same manner as is indicated in Fig. 199 (b). Put another way, it could be said that the direct current would itself magnetise the pole pieces, whereupon it would make the permanent magnet superfluous. In practice, however, this scheme is unattractive, as an inconveniently high direct current would be required to provide the same level of flux density as is given by a practical magnet. Apart from the difficulty of providing such a current, its high value would necessitate thicker wire in the coils than is required for signal currents and the earphone would become needlessly bulky and costly as a result.

It should be mentioned that, in some radio applications, circuit conditions are such that it is desirable to allow a small direct current to flow through the coils of an earphone in addition to the alternating signal current. The presence of such a direct current is, in general, permissible provided that it does not greatly exceed the peak value of the alternating current. The direct current should, preferably, flow in the direction which causes the resulting magnetic flux due to the coils to assist that due to the permanent magnet, but this is not entirely obligatory with modern earphones. In most instances, the magnetic flux due to a direct current of permissible level is much smaller than that given by the magnet, and the loss of sensitivity resulting from direct current flow in the incorrect direction is negligibly low. With earlier earphones it was considered that a direct current in the incorrect direction would, with time, cause partial demagnetisation of the permanent magnet and, hence, loss of sensitivity. There is little risk of this eventuality when modern magnet materials are employed. It should be added that, to ensure direct current flow in the correct direction, earlier earphones had one terminal marked with a "+" sign. This was the terminal which should then connect to the positive side of the source of direct current.

Practical Features

The earphone construction shown in Fig. 195 is typical of the larger, non-miniature, type of magnetic diaphragm earphone and it aptly demonstrates the basic method of operation. In some earphones of this type, usually of later design, the horseshoe magnet is replaced by a small bar magnet as illustrated in Fig. 200.

The pole pieces of the earphones shown in Figs. 195 and 200 are made of soft iron or of a magnetic material having similar properties. Occasionally, they may be laminated. The faces adjacent to the diaphragm are machined to provide an accurately dimensioned flat surface. The diaphragm is made from a high permeability material similar to that

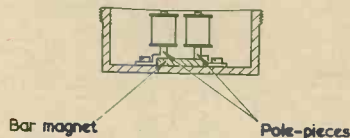

Fig. 200. An alternative construction to that of Fig. 195 employs a bar magnet instead of a horse-shoe magnet. The method of coupling the pole pieces to the bar magnet may differ, in some units, to that shown here, although the basic principle remains the same

used for transformer laminations, and it has a japanned finish to prevent rust.

Since the war, miniaturised earphones have become generally available, these being employed for hearing aids or as "personal" earphones for use with small portable radio receivers. They have the general appearance shown in Fig. 201, wherein the moulded projection is intended to fit directly into the auditory canal of the ear. The weight of such earphones may be considerably less than 1oz, as compared with the 2 to 5oz of an earphone using the construction of Fig. 195 or Fig. 200.

In order to achieve their small size, miniature earphones employ the typical construction shown in Fig. 202. In this diagram there is a single rod magnet mounted on a circular base of magnetic material and a single coil. A cylindrical pole piece ensures that both poles of the field from the magnet closely approach the diaphragm. The latter is made of springy magnetic material and is usually thinner than the diaphragms employed in the construction of Figs. 195 or 200. A thicker disc of magnetic material may be affixed to the centre of this diaphragm, as illustrated in Fig. 203, to provide bulk for the passage of magnetic flux. A small acoustic chamber appears in front of the diaphragm, a hole at its centre coupling to the projection which fits inside the auditory canal. Due to the small size of the assembly, the volume of air behind the diaphragm may be comparable with that in the chamber at the front, and the consequent compressions and rarefactions of this small volume of air could impede the movement of the diaphragm. To overcome this difficulty, it is usual to provide a small hole in the housing behind the diaphragm to ensure that the air behind it is not completely trapped.

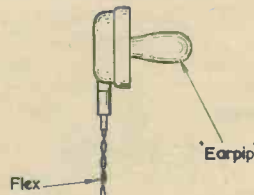

Fig. 201. The appearance of a typical miniature earphone

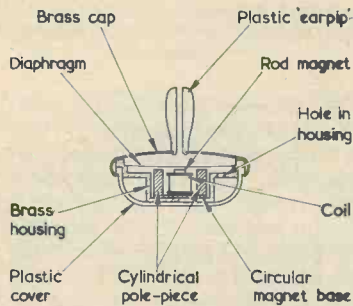
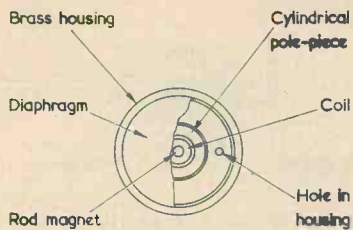

Fig. 202. A typical construction for a miniature earphone. In (a) we see the assembly behind the diaphragm, whilst (b) shows a cross-section through the complete earphone. The circular magnet base is made of magnetic material and completes the magnetic circuit between the lower ends of the rod magnet and the cylindrical pole piece

When we discussed impedance matching³ we saw that it is desirable for a load connected to a generator to have a specific impedance for optimum transfer of power or to meet certain requirements in the circuit represented by the generator. An earphone may be considered as a load, with the consequence that it is necessary for it to have a specific impedance for operation with a particular circuit.

In the earlier days of radio, however, it was usual to refer to earphones in general terms of their coil resistance. The usual resistance figure for an earphone (i.e. the resistance of its two coils connected in series) was $2,000\Omega$, and such earphones were normally series-connected in pairs to form a headset having a total resistance of $4,000\Omega$. Headsets with a resistance of $4,000\Omega$ have been in general use for radio work for many years and are still employed

³ In "Understanding Radio" part 23, July 1963 issue.

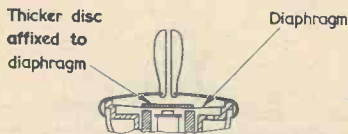

Fig. 203. A thicker disc of magnetic material may be affixed to the centre of the diaphragm in miniature earphones

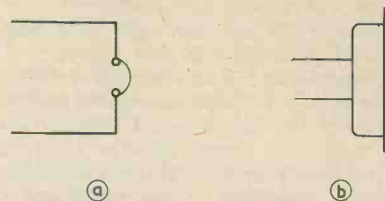

Fig. 204 (a). The circuit symbol for a headset comprising two earphones
(b). The symbol for a single earphone

very frequently at the present time.

During the war, the Services, including the R.A.F. in particular, commenced to employ equipment which required magnetic diaphragm headphones with much lower resistances, a typical figure being 50Ω per earphone. Since the lower resistance was given by employing coils with fewer turns of thicker wire, the impedance was lowered also.

Miniature earphones intended for connection to portable receivers or for use with hearing aids are normally specified both by their resistance and by their impedance at 1 kc/s. They are manufactured with a wide range of impedances, these varying from about 8Ω to $1k\Omega$ or more. The reason for the wide range has been partly due to the introduction of transistorised equipment, which may require earphones having specific impedances (with relatively close tolerances) which are lower than is offered by the larger earphone with a resistance of $2,000\Omega$.

Advantages and Disadvantages of the Magnetic Diaphragm Earphone

The earphone of the type we have just discussed has a number of advantages and disadvantages which we should now consider.

The main advantages are its sensitivity, its simplicity and its robustness. So far as the first attribute is concerned, the inherent sensitivity of the earphone is enhanced by the fact that its small size and light weight enable it to be placed very close to the ear. In the case of the miniature earphone it may, indeed, be introduced into the auditory canal itself.

The greatest disadvantage of the magnetic diaphragm earphone is that it tends to have a limited frequency response and that it does not provide an audible signal which is a true equivalent of the electrical signal fed to it. It is also possible for resonant conditions to appear in the volume of air both behind and in front of the diaphragm, and in the diaphragm itself. These can cause some frequencies in the audible range to be reproduced at greater level than others.

Despite this shortcoming, the earphone is an extremely valuable device for radio work. It provides a quality of reproduction which is quite acceptable for speech and which may offer adequate entertainment value for music.

Circuit Symbols

In circuit diagrams, a pair of earphones, constituting a headset, is depicted in the manner shown in Fig. 204 (a). A single earphone may be depicted as illustrated in Fig. 204 (b).

Next Month

The writer had hoped to introduce the loudspeaker in this month's article, but it appears that the space available will not allow this. In consequence, we shall carry on to the loudspeaker next month.

ELECTRONIC "Watch Dog"

By R. M. QUAILE

Home-constructed devices which, during their development, arouse the interest of the B.B.C. and the national press do not always provide subjects for our articles! Nevertheless, this has been the fate of the electronic "watch dog" which is described here. The device requires no critical components, it gives audible warning of the approach of visitors or intruders, and it provides automatic front path lighting

- (1) It gives audible warning by buzzer or bell of the approach of persons.
- (2) It warns occupants of the house as to whether the garden gate is open or shut by lighting appropriate lamps.
- (3) It automatically lights the garden path for visitors as soon as the gate is opened.
- (4) It similarly lights the way for occupants leaving the house.

The lighting facility offered by items 3 and 4 is of particular value in my case, as street lamps outside my house are very few and far between.

The Circuit

The circuit of the electronic "watch dog" appears in Fig. 1.

IN ITS INITIAL STAGES THE ELECTRONIC "watch dog" unit which is described in this article was designed to close an electrical circuit for a fixed short period after the front garden gate had been opened. Under this condition it could then cause a bell or buzzer to sound, thereby offering audible warning of the approach of a visitor.

The device was originally built to let my wife know if my young son had wandered out on to the main road outside. For the amusement of my other children I later coupled the unit to a tape recorder fitted with an endless loop of tape. This recorder was set up so that it continuously announced "Bandits . . . Bandits . . . Bandits" whenever the gate was opened. To my amazement, the device was reported in no less than five newspapers, including the *Daily Express*, and was the subject of a B.B.C. broadcast recorded in my house!

Functions Offered

In its present state, the device does not offer facilities which are quite as sensational but it is, nevertheless, a very useful adjunct to the home. Furthermore, it requires no attention and its operation is simple and completely foolproof.

The functions offered by the device are:

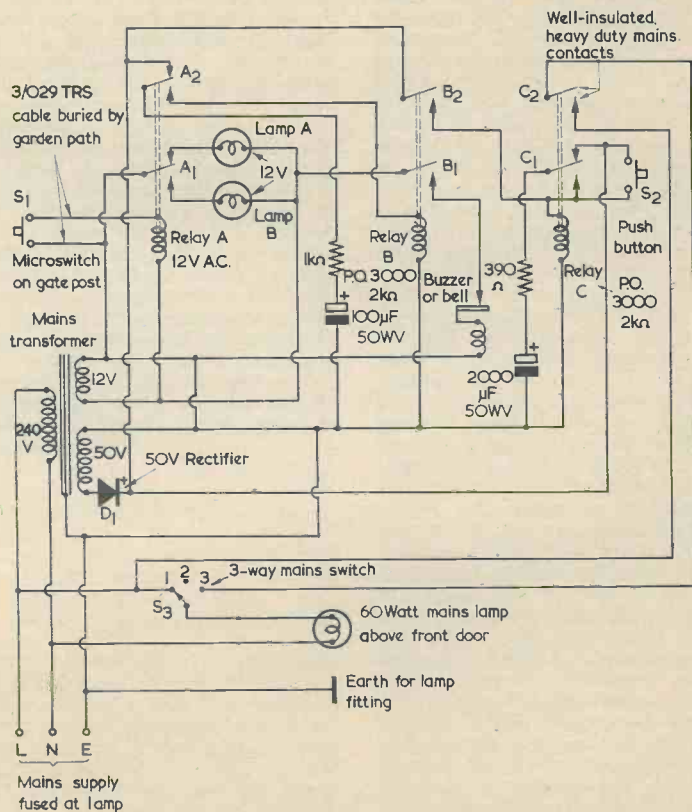

Fig. 1. The complete circuit of the electronic "watch dog".

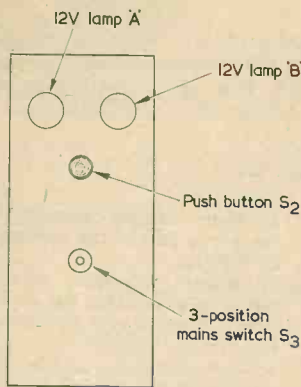

Fig. 2. The control panel. This may be fitted inside the house near the front door

When the gate is shut, micro-switch S_1 is open and all relays are in the de-energised condition. The fact that the gate is closed is indicated by 12 volt lamp "A", which is illuminated by way of relay contact A1. At the same time, the $100\mu\text{F}$ electrolytic capacitor is allowed to charge up, via contact A2, to the potential on the 50 volt supply offered by the 50 volt mains transformer winding and rectifier D_1 . Similarly, the $2,000\mu\text{F}$ electrolytic capacitor charges up to the potential on the 50 volt supply by way of contact C1.

When the gate is opened, micro-switch S_1 closes, applying 12 volts a.c. to the coil of relay A, which then energises. Contact A1 transfers the 12 volt supply to lamp "B", and lamp "A" becomes extinguished. Lamp "B" now indicates that the gate is open. At the same time, contact A2 connects the charged $100\mu\text{F}$ capacitor across the coil of relay B, which then becomes energised for some 6 to 8 seconds until the $100\mu\text{F}$ capacitor discharges. Whilst relay B is energised its contact B1 connects the buzzer (or bell) across the 12 volt supply, causing it to give an audible warning. When relay B energises, its contact B2 applies the 50 volt supply to relay C which also energises, whereupon its contact C1 causes the already-charged $2,000\mu\text{F}$ capacitor to be connected across its coil. When contact B2 falls open after relay B de-energises, relay C remains held on by its own contact C1. It de-energises some 25 to 30 seconds later when the $2,000\mu\text{F}$ capacitor becomes discharged.

If the 3-way mains switch S_3 is in position 3, contact C2 causes

a 60 watt mains lamp in a swan neck fitting outside the front door to be illuminated during the period when relay C is energised.

When, either during or after the operations just described, the front gate is closed again, relay A de-energises, causing lamp "B" to be extinguished and lamp "A" to light up. If the gate were closed during the 6 to 8 second period during which relay B is energised, this relay would de-energise also. However, such an eventuality is unlikely to occur in practice and the period during which the gate is open will, in any case, be sufficiently long for the audible warning to be effective. The 25 to 30 second switching cycle offered by relay C remains unaltered whether the gate is closed within the 6 to 8 second period or not.

The operations resulting from opening the gate may now be summarised in the following manner. Before the gate is opened lamp "A" is illuminated. On opening the gate, lamp "B" becomes illuminated, a buzzer is caused to sound for a 6 to 8 second period of time, and (when S_3 is in position 3) the external front door lamp becomes illuminated for 25 to 30 seconds. On closing the gate, lamp "B" becomes extinguished and lamp "A" lights up.

The 3-way switch S_3 provides two other functions in addition to that just described. In position 1 it causes the front door lamp to be illuminated continually. In position 2 it cuts the lamp out of circuit, with the result that the unit only causes the buzzer to sound when the gate is opened. As has already been noted, in position 3 it connects the lamp into the "watch dog" circuit.

A further facility is offered by push-button S_2 . This button may be pressed when leaving the house,

whereupon it causes relay C to become energised until the $2,000\mu\text{F}$ capacitor discharges. Sufficient time is then provided for the occupant to leave the house and garden before the external front door lamp switches off again.

Construction

As may be gathered from the circuit diagram of Fig. 1, the components required are not in any way critical. In the prototype, relays B and C were both P.O. 3000 types with $2k\Omega$ coils. Relay A was a 12 volt a.c. component which had no identification marks. If any difficulty is experienced in obtaining a 12 volt a.c. relay, it could be replaced by a third P.O. 3000 type, the coil of the latter being energised (via the gate microswitch) from the rectified 50 volt supply.

The mains transformer was originally taken from an unidentified battery charger. Its secondary, rated at 17 volts 5 amps, was removed and new secondaries re-wound with 23 s.w.g. enamelled copper wire to give 12 and 50 volt outputs.

The rectifier D_1 can be either a selenium or silicon type intended for 50 volt operation at some 50mA or so. The peak inverse voltage is 140, and this allows silicon rectifiers such as the XU612 to be used. The prototype employed a rectifier taken from ex-A.M. equipment, but the type required is not at all critical.

The $1k\Omega$ and 390Ω resistors in series with the electrolytic capacitors are included to prevent current surges and possible sparking at the relay contacts. They may be $20\% \frac{1}{2}$ watt components.

The controls and 12 volt lamps were mounted inside the house on a wall near the front door. The control box has the appearance

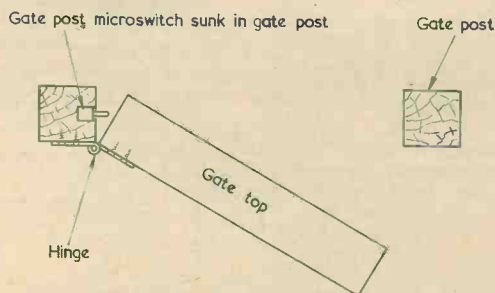

Fig. 3. A simple and satisfactory method of mounting the microswitch at the gate

shown in Fig. 2.

Constructors may have varying ideas on the mounting of the

microswitch at the gate. The method employed in the prototype installation is shown in Fig. 3.

This has proved to be perfectly reliable with time, and has the advantage of being inconspicuous.

IN YOUR WORKSHOP

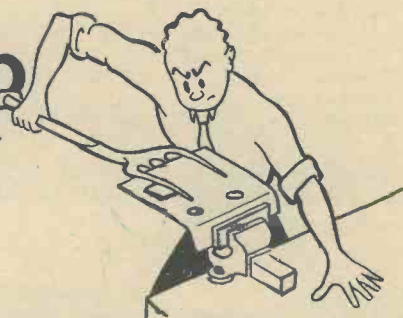

This month, Smithy the Serviceman, aided as always by his able assistant Dick, embarks on a subject concerning which a number of readers have asked for information. This subject is the alignment of home-built superhets without a signal generator, and Smithy will conclude his discussion in next month's issue

“YOU CAN'T HAVE IT,” SAID Smithy. **“And that's final!”**

To emphasise his point the Serviceman banged the thoroughly disreputable tin mug he was holding down on his bench. A little fountain of tea shot up into the air, to fall harmlessly back inside the confines of the mug.

“It's only,” wheedled Dick, “for one night. One night only.”

“I'm sorry,” repeated Smithy, flatly. “But you just can't have it.”

The Serviceman turned an aggrieved eye over the Workshop benches.

“Dash it all,” he continued, “we'll have nothing left in the Workshop at all soon. On Monday night you borrowed both a large and a small soldering iron, and I have no doubt that you also secreted about your person a goodly quantity of our cored solder as well. On Tuesday night you borrowed three screwdrivers, a set of B.A. box spanners, two pliers, a pair of side-cutters and a hammer. And on Wednesday you borrowed the highest resistance test-meter we've got in the place. It's now Thursday, and I was hoping that you had at last satisfied your desire to set up a second Workshop in your back bedroom. But no. You now want to borrow our best signal generator as well!”

Smithy reached round, picked up his disgraceful mug and drank deeply of its contents. Refreshed, he returned to the attack.

“What are you building, anyway,” he queried, “your own domestic digital computer?”

Superhet Alignment

“It's nothing like that at all,” replied Dick hotly. “What I've just knocked up is a little medium and long wave superhet. All I need now is a signal generator to line it up with.”

“Is that all?” queried Smithy incredulously. “Just a medium and long wave superhet?”

“That's right,” replied Dick eagerly. “I could get it finalised tonight if I had the signal genny.”

Smithy thought for a moment.

“Did you,” he asked, “obtain your coils and i.f. transformers brand-new?”

Dick looked a little puzzled at Smithy's question.

“It so happens,” he remarked, “that I did.”

“And have you,” continued Smithy, “played around with their iron dust cores in any way?”

Dick's perplexed expression deepened.

“As a matter of fact,” he remarked, “I've left them severely alone. But what difference does that make?”

“It makes the important difference,” replied Smithy triumphantly, “that I'm actually doing you a favour by not letting you have the signal genny! Provided they're put together properly, and the iron dust core settings in the coils haven't

been altered, most home-made medium and long wave superhets can be lined up quite accurately without a signal generator at all. It will be good experience for you to attempt it with that set of yours!”

“I think that's pretty rotten of you,” commented Dick disgustedly. “If I had that signal genny I could line the set up in no time at all. Without it, I wouldn't even know where to start.”

“All you have to do,” remarked Smithy, “is to remember your basic superhet theory.”

“I do remember it,” said Dick. “But I still wouldn't know where to start!”

“Then the practice you gain will be even more useful to you,” replied Smithy heartlessly.

He glanced at the clock.

“I see,” he added, “that we've got quite a bit of tea-break time left, so I might as well devote it to giving you a bit of introductory gen on this particular subject.”

Smithy drew a pad of papers towards him and beckoned his assistant over. Obediently, Dick picked up his stool and sat at the Serviceman's side.

“The best way to start on this subject,” said Smithy, “is to get down to first principles straightaway. We'll commence by considering a four valve superhet covering medium-waves only. I'm choosing a valve set instead of a transistor set as an example because it's a little easier

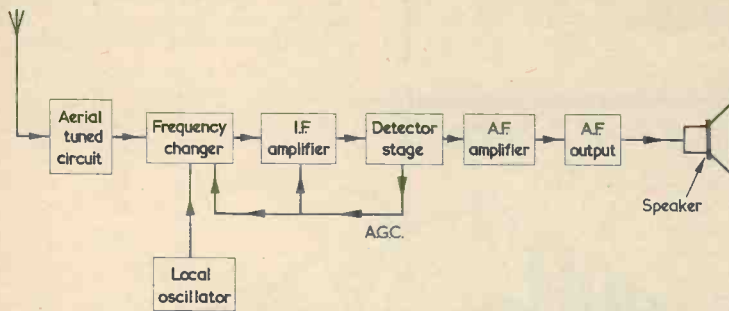

Fig. 1. Block diagram of a medium wave superhet. The aerial tuned circuit is shown as a separate block for purposes of explanation

to show the various stages."

Smithy scribbled out a diagram on his pad. (Fig. 1.)

"The first thing we need to look at," he continued, "is this block diagram of the receiver. Working back from the speaker we have the a.f. amplifier and output stages, these being preceded by the detector stage. The latter provides the a.f. modulation which is present on the signal, as well as an a.g.c. voltage. Sometimes a single diode does these two things, and sometimes two diodes are used. Before the detector stage, we have the i.f. amplifier."

Smithy paused.

"Now what," he asked, "is the function of the i.f. amplifier?"

"That's obvious," replied Dick scornfully. "It's to provide amplification at the intermediate frequency."

"Is that all?"

Dick thought for a moment.

"I can't think," he confessed eventually, "of anything else it's supposed to do."

"Your answer is perfectly right," admitted Smithy, "but I'm afraid it tends to put some of the emphasis in the wrong place. The i.f. amplifier does provide amplification at the intermediate frequency and, in so doing, imparts a considerable degree of sensitivity to the overall receiver. But it has a second attribute. Since it contains a relatively large number of tuned circuits, the i.f. amplifier also imparts a very high degree of *selectivity* to the receiver. The i.f. amplifier allows only those signals which fall within its pass-band to be fed to the detector, and it rejects all signals on either side. In other words it rejects all adjacent channel signals. Indeed, the i.f. amplifier offers practically all the adjacent channel rejection which the set is capable of doing."

The Frequency Changer Stage

"I get your point," said Dick. "Shall we carry on back to the frequency changer stage next?"

"If you like," agreed Smithy. "As you know, the frequency changer stage incorporates a local oscillator in addition to the frequency changer circuits themselves, the oscillator and frequency changer functions being usually carried out by a single triode-heptode or triode-hexode. You know also that the oscillator frequency in any conventional superhet is spaced above the frequency of the required aerial signal by the intermediate frequency. Thus, if the intermediate frequency is 470 kc/s and we want to receive an aerial signal of 1,000 kc/s, we set the oscillator to 1,470 kc/s. O.K.?"

"Sure," said Dick, a little impatiently. "The 1,470 kc/s from the oscillator beats in the frequency changer section with the 1,000 kc/s aerial signal to give the 470 kc/s intermediate frequency. Dash it all though, Smithy, isn't all this very elementary stuff?"

"It is," agreed the Serviceman, "but I'm trying to lead up to a very important point. What I want you to appreciate is that we are only receiving our 1,000 kc/s signal because the oscillator frequency is set to 1,470 kc/s. If we want to receive a signal on say 1,200 kc/s, then we do this by setting the oscillator to 1,670 kc/s. And, if we want to receive a 1,400 kc/s signal, we set the oscillator to 1,870 kc/s. In other words, the signal we receive is selected by the oscillator circuit only. When we adjust the frequency of the oscillator we are selecting the frequency which will be passed to the intermediate frequency amplifier. The intermediate frequency amplifier provides practically all the adjacent channel selectivity for the

receiver, and the oscillator circuit selects the signal which will be passed on to that amplifier. The result is that adjusting the oscillator tuning capacitor has the same effect on station selection as would be given by adjusting, say, a whacking great 4-gang tuning capacitor in a straight receiver with all tuned circuits perfectly aligned!"

Dick looked impressed.

"I must confess," he remarked, "that I hadn't quite looked at the oscillator circuit in that manner."

"You should," replied Smithy.

"The oscillator circuit is that which selects the signal which is received by the set. If you change the oscillator frequency, then you receive a different signal."

"What about the aerial tuned circuit?"

"The function of the aerial tuned circuit," said Smithy, "is twofold. Firstly, it has to bring the desired signal to as high a level as economic tuning circuit design will allow, whereupon it is then fed to the signal grid of the frequency changer for beating with the oscillator signal. Secondly, the aerial tuned circuit has to keep out unwanted signals."

"What unwanted signals?"

"The unwanted signals," replied Smithy, "which appear due to the superhet principle. These consist of the intermediate frequency itself, and of the second channel signal. Without an aerial tuned circuit, aerial signals at the intermediate frequency can pass straight through into the frequency changer and, thence, to the i.f. amplifier. Whilst there are no broadcasting stations in the 455 to 480 kc/s range in which the intermediate frequencies for domestic a.m. receivers appear, these frequencies still fall inside the 415 to 490 kc/s marine telegraphy band. Without the aerial tuned circuit, therefore, you could pick up quite a bit of ship's morse in some localities. So far as second channel interference is concerned, we need only return to our previous example to give a simple instance of this. We picked up an aerial signal at 1,000 kc/s by setting the oscillator to 1,470 kc/s. If, under these conditions, an aerial signal at 1,940 kc/s found its way to the frequency changer signal grid, this would similarly beat with the 1,470 kc/s oscillator frequency to give 470 kc/s, whereupon the 1,940 kc/s signal would also pass into the i.f. amplifier. The 1,940 kc/s is a second channel signal and, as you can see, is twice the intermediate frequency above the required signal. The function of the aerial tuned circuit is to prevent second channel signals of this sort arriving at the

signal grid of the frequency changer."

Smithy paused for a minute, and carefully inspected the contents of his mug.

"I should add," he continued, "that, since the aerial tuned circuit is intended to prevent signals at the intermediate and second channel frequencies reaching the signal grid of the frequencer changer, it is capable of doing this most effectively when it causes the required signal to be passed on at optimum level. This increases the ratio between the wanted and unwanted signals, which is exactly what is required. In practice, when signals at i.f. and second channel frequency do get past the aerial tuned circuit, they cause whistles by beating with the required signal as the tuning capacitor is adjusted over the band. If ever you get this effect with an a.m. superhet you want to check the condition of the aerial tuned circuit. Very often, the whistles will drop in level or disappear if you make certain that the aerial tuned circuit is resonant at exactly the frequency of the required signal. Because the wanted signal is then passed to the frequency changer signal grid at an increased level, the effect of the unwanted signals is proportionately less and the whistles become weaker or disappear altogether."

"Since the wanted signal," interjected Dick, "is now at higher level, I presume that you could say that a.g.c. action makes the receiver less sensitive to the unwanted signals."

"That's true enough," agreed Smithy. "Anyway, to sum up all I have said up to now, you have to remember, firstly, that practically all of the adjacent channel selectivity in the receiver is provided by the i.f. amplifier. Secondly, signal selection is carried out by the oscillator, because it is the oscillator frequency that determines which aerial signal will be fed into the highly selective i.f. amplifier. And, thirdly, the functions of the aerial tuned circuit are to ensure that the required signal is passed to the frequency changer at optimum level, and that signals at the intermediate frequency and second channel frequency are kept out. I should perhaps add that, in some sets, the aerial tuned circuit will also add a little to the adjacent channel selectivity given by the i.f. amplifier, but this point is unimportant so far as alignment techniques are concerned."

Trimming and Padding

Smithy held his disgraceful tin mug to his lips and drained its contents. With a loud smack of the lips

he passed it to his assistant, who accepted it with obvious revulsion.

"I can't understand," commented Dick, as he made his way to the heterogeneous array of utensils at the Workshop sink, "how you can even bring yourself to have this repulsive object in the place, least-ways actually drink out of it!"

"What repulsive object?"

"This filthy old tin mug," called out Dick over his shoulder. "It must have fallen off the rag and bone man's cart."

An expression of incredulous affront spread over Smith's face.

"If you are referring to my drinking vessel," he snorted indignantly, "I must inform you I was issued with that at Aldershot in 1941."

"Blimey," commented Dick, holding the article under discussion at arm's length as he filled it from the battered teapot, "I didn't know the Pioneer Corps even got as far as Aldershot!"

"Furthermore," continued Smithy, ignoring his assistant's comment, "that mug has seen service in East Africa."

"East Acton would be more like it!"

"And, finally," said Smithy, with dignity, "I consider it my duty, as an ex-serviceman, to keep all the Army kit I have in a state of complete readiness."

"I can see the point of that," chuckled Dick as he walked back to the bench. "Throw a few mugs like this in amongst the enemy and

they'd all be down with bubonic plague!"

"Nonsense," said Smithy. "Just because there are one or two bits of enamel missing here and there, it doesn't mean to say that this mug is in any way unhygienic. Anyway, let's get back to that superhet."

"As you like," said Dick, placing Smithy's refilled mug on the bench at as great a distance from himself as was possible.

"Right," said Smithy briskly. "We have already discussed the functions of the i.f. amplifier, the oscillator section and the aerial tuned circuit, so let's carry straight on to the actual business of alignment. We'll start off at the frequency changer, and we'll continue to talk in terms of a medium wave valve superhet."

The Serviceman sketched out a second diagram on his pad. (Fig. 2.)

"What I've drawn here," he announced, "is the sort of frequency changer circuit which used to be particularly common in the old days. It differs from the circuit you see in modern sets because both the aerial and oscillator coils are air-cored and because it has a variable padding capacitor. Since the coils do not have adjustable iron dust cores their inductances are fixed, and cannot be altered. Let us now assume that the 2-gang tuning capacitor in the circuit is fitted with a scale calibrated in wavelength or frequency and that it has a nominal capacitance of 500pF in each section. Also, that the i.f. is

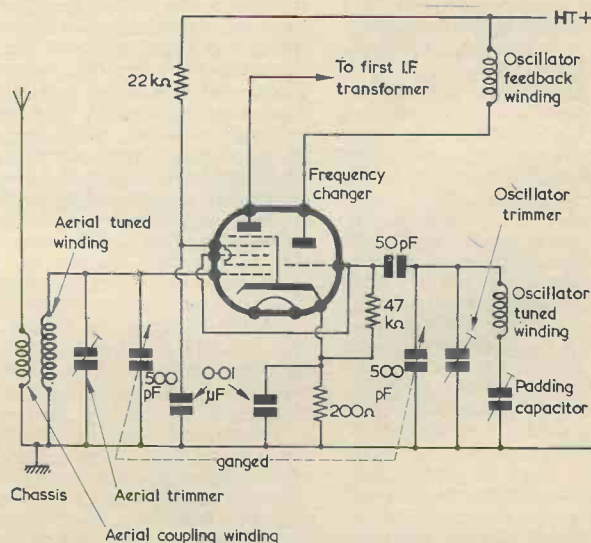

Fig. 2. A typical medium wave frequency changer stage, with representative component values. An a.g.c. circuit is not shown. The aerial and oscillator coils are air-cored

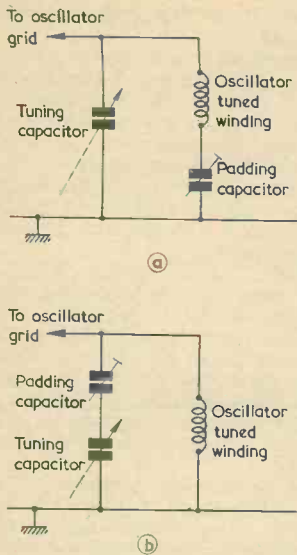

Fig. 3 (a). The padding capacitor of Fig. 2 is in series with the oscillator tuned circuit

(b). The padding capacitor would have the same effect on oscillator resonant frequency if it were more obviously connected in series, as shown here

470 kc/s and the i.f. amplifier has already been lined up. With this frequency changer stage we want to cover a band of some 200 to 500 metres which is, near enough, the conventional medium wave band."

"Those are nice easy figures," commented Dick approvingly. "200 metres is 1,500 kc/s and 500 metres is 600 kc/s."

"Exactly," confirmed Smithy. "And these figures mean that the oscillator has to cover 1,970 to 1,070 kc/s if it is to be 470 kc/s above aerial signal frequency. The ratio of top and bottom aerial signal frequencies is 1,500 to 600, or 5 to 2. At the same time, the ratio of top and bottom oscillator frequencies is 1,970 to 1,070, which is slightly less than 2 to 1. Since the oscillator tuned circuit has to offer a lower ratio between its top and bottom frequencies than does the aerial tuned circuit, it seems reasonable to expect that it requires a lower tuning capacitance. In the circuit I've just drawn, this lower tuning capacitance is provided by inserting a padding capacitor in series with the oscillator tuned circuit. (Fig. 3 (a).) The fact that the chassis connection appears at the junction of the tuning and padding capacitors is not of importance here, and the

padding capacitor has the same effect on resonant frequency as it would have if it were more obviously in series with the tuning capacitor, say at the top end. (Fig. 3 (b).) The first circuit is more convenient in practice, however, especially when band-switching from medium to long waves is employed."

Smithy took a sip from his replenished supply of tea.

"We can now," he said, "start to align our circuit. As you can see, in addition to the variable padding capacitor we have two variable trimming capacitors in parallel with the two sections of the tuning capacitor. These trimmers are relatively low-value components, and will have a maximum capacitance of about 60pF or so. Since they are connected across the tuning capacitor sections, they have greatest effect on resonant frequency when the tuning capacitor is set to the minimum capacitance end of its travel. Which is, of course, the high frequency end of the tuning range. We start off, therefore, by adjusting the trimmers at the high frequency end of the range. However, it isn't usual practice to adjust the trimmers with the tuning capacitor vanes fully disengaged, and we normally engage the vanes by about 10 to 20 degrees before we commence the trimming operation. (Fig. 4 (a).) One reason for this is that any slight discrepancies in value between the two sections of the 2-gang capacitor do not, for obvious reasons, show up when the vanes are completely disengaged. If they are slightly enmeshed the trimming operation takes up tuning capacitor discrepancies at that setting as well as the stray capacitances in the two circuits. I should add that, if we were aligning a commercial receiver or a home-constructor kit set, there may well be alignment instructions which would tell us the exact point at which we should set the tuning capacitor for trimming purposes."

Smithy took yet another sip at his tea.

"Right!" he remarked, refreshed. "The first trimmer to attack is the oscillator trimmer. The tuning scale will indicate a wavelength or frequency corresponding to the tuning capacitor position and, if we have a signal generator, we set this to that frequency and apply its output to the aerial input circuit. We then adjust the oscillator trimmer so that the signal generator signal is applied to the i.f. amplifier. In other words, we set the oscillator trimmer so that oscillator frequency is 470 kc/s above signal generator frequency, with the result that the latter is passed into the highly selective 470 kc/s i.f.

amplifier. Adjusting the oscillator trimmer gives the same effect as 'tuning in' the signal by means of the tuning knob on the front of the set."

"What happens if you haven't got a signal generator?"

"You work with a known broadcast signal," replied Smithy, "which appears at about the right place on the dial. You set the tuning dial to the wavelength or frequency of that signal and 'tune it in' with the oscillator trimmer. Incidentally, I'll be going into greater detail about alignment without a signal generator later on."

"Fair enough," commented Dick. "What happens after setting up the oscillator trimmer?"

"We then," replied Smithy, "adjust the aerial trimmer. In this case, though, we merely adjust the trimmer for maximum signal strength. You must remember that we've already 'tuned in' the signal with the oscillator trimmer. Now that we've got the signal going into the i.f. amplifier, all we need to do is to bring it up to maximum amplitude with the aerial trimmer. The latter doesn't 'tune in' the signal, it just increases its strength. O.K.?"

"Sure," responded Dick. "I'm with you all the way!"

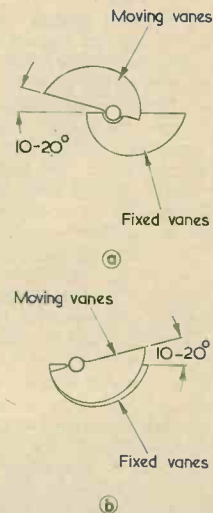

Fig. 4 (a). In the absence of specific alignment instructions, normal practice consists of carrying out trimming operations with the tuning capacitor vanes enmeshed for some 10 to 20 degrees

(b). Similarly, padding adjustments may be made with the vanes some 10 to 20 degrees short of being fully enmeshed

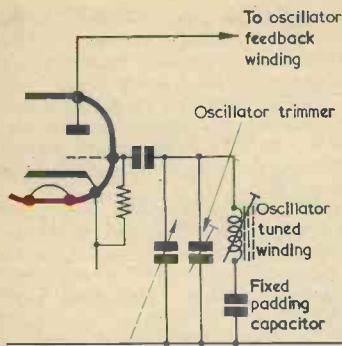

Fig. 5. The air-cored oscillator coil of Fig. 2, with its variable padding capacitor, may be replaced by an iron dust cored coil and a fixed padding capacitor

"Good," said Smithy. "The next job is to carry out a padding adjustment at the low frequency end of the range. We've already seen that the parallel trimmers have greatest effect when the tuning capacitor is at the low capacitance end of its range. It follows that the series padding capacitor will have greatest effect when the tuning capacitor is at the maximum capacitance end of its range. So we turn the tuning capacitor until its vanes are fully enmeshed except for about 10 to 20 degrees or so (Fig. 4 (b)) and start the padding operation. Note that we don't fully enmesh the vanes. If we did, we'd be adjusting for a tuning capacitor position which would only correspond to reception right at the bottom frequency point of the band. If there are alignment instructions for the receiver, these will, as at the high frequency end, tell us the exact position we should set the tuning capacitor to. Without such instructions it's satisfactory to have the tuning capacitor fully enmeshed except for about 10 to 20 degrees.

"Our tuning scale," continued Smithy, "will now indicate a new wavelength or frequency and, if we have a signal generator, we set it to that frequency and once more inject its output into the aerial circuit. We then adjust the padding capacitor. Since this alters oscillator frequency, we once more have the 'tuning in' effect. In consequence, we adjust the padding capacitor to 'tune in' the signal generator frequency. If we haven't got a signal generator, we 'tune in' at the appropriate position on the scale, a known broadcast signal whose frequency is close to the desired point on the dial. No further adjustment can then be carried out at this end of the range with our

present circuit because there are no more variable components available. The next point is that our padding adjustment may have put things a little bit off alignment at the high frequency end of the band. In consequence, we return to the previous trimming frequency and repeat the trimming operation all over again. Since this could, in its turn, slightly alter the padding adjustment, we then return to the low frequency end and finally repeat the padding adjustment. Unless the adjustable components were miles off in the first place, the two trimming and padding adjustments I've just described should be enough to bring the whole circuit into full alignment. You can always repeat the trimming and padding processes a third time if you feel in a perfectionist mood."

Iron Dust Cores

"There's a snag here," frowned Dick. "But I can't quite put my finger on it."

"There is a snag," grinned Smithy. "And to save time I'll tell you exactly what it is. In the process I've just discussed it is assumed that the aerial circuit will be resonant at exactly the correct frequency when we adjust the padding capacitor. Unfortunately, we have no guarantee of this and there is, really, a further padding operation which should be carried out with circuits employing air-cored coils if we want to ensure that we are getting the best results possible. We set the tuning capacitor to the padding frequency as I've just described and carry out the padding operation. We then check the condition of the aerial tuned circuit by experimentally turning its trimmer, always bringing it back to its correct position after each check. If, to take an example, the aerial trimmer indicates that the aerial tuned circuit requires more capacitance to become exactly resonant at signal frequency, we then further enmesh the tuning capacitor vanes slightly to give that extra capacitance, and readjust the padding capacitor. After which we check with the aerial trimmer once again. When this process has been carried out several times we should have the aerial tuned circuit spot on frequency at the padding position."

"Blimey," remarked Dick, "that sounds a long-winded process!"

"It is, rather," admitted Smithy. "A simpler method consists of rocking the tuning capacitor back and forth over a small range on either side of the padding frequency, adjusting the padding capacitor at the same time. The point at which the required signal appears on the dial will shift around as we adjust

the padding capacitor, and its strength will increase as we adjust in one direction. We adjust the padding capacitor for maximum signal strength as we pass through the signal whilst rocking the tuning capacitor. That is then the final padding capacitor setting, because it allows the aerial section of the tuning capacitor to present exactly the right capacitance to the aerial coil at the padding frequency."

"There's another snag here," said Dick. "If you adjust the padding capacitor in the manner you've just described, the tuning dial calibration will be incorrect at the low frequency end of the band."

"That's right," grinned Smithy. "And that was, indeed, one of the problems service engineers used to have in the old days with superhets which employed air-cored coils. The snag is that, with these coils, we have to rely on the aerial coil having exactly the right inductance to match up to the tuning capacitor and the tuning dial. Usually, they *did* match up, but if they didn't, we had to bodge things up a bit. What I used to do myself was to set up a receiver of this sort for maximum signal strength at the padding frequency, and blow the dial calibration! In most cases, however, the dial calibration was only slightly out and it could usually be put right by setting the pointer so that it was correct at the padding frequency. A little adjustment of the trimmers would then make the calibration correct at the high frequency end as well. But I'm digressing a little here, because difficulties of this nature don't crop up with modern coils!"

"Why's that?"

"Because," replied Smithy, "modern coils have adjustable inductances. With some of these, the adjustment is given by iron dust cores which can be screwed in or out of the winding."

Dick looked puzzled.

"I didn't know," he remarked, "that there were other types."

"Of course there are," snorted Smithy. "You get coils with varying inductances on ferrite frame aerials. You adjust their inductance by sliding the coils along the rod."

"Dear, oh dear," chuckled Dick. "I'd forgotten all about them!"

"Anyway," said Smithy, "the coils I'd like to deal with for the moment are those with iron dust cores. Nowadays, you will almost inevitably encounter these in the oscillator circuits, whereupon they replace the coils with fixed inductance we've considered up to now."

Smithy scribbled a further circuit on his pad. (Fig. 5.)

"In this circuit," he remarked, "an oscillator coil with an adjustable iron dust core replaces the previous air-cored type we considered. Also, the variable padding capacitor is replaced by a fixed capacitor having a value which is suitable for the range of frequencies to be covered. Despite these changes, the business of trimming and padding is pretty well the same as before, except that, in this instance, we do not adjust the padding capacitor at the padding frequency. Instead, we adjust the oscillator coil iron dust core. With a circuit of this nature we start off by setting the tuning capacitor to the trimming frequency at the high frequency end of the band, and we 'tune in' the required signal frequency with the oscillator trimmer, as before. We then, also as before, bring that signal up to a peak with the aerial trimmer. We next go to the padding frequency

at the low frequency end of the band, whereupon we 'tune in' the required signal by adjusting the oscillator coil core. We repeat the trimming and padding processes again, after which we're fully lined up.

In Our Next

"You still have the same snag as before," objected Dick. "If the aerial coil hasn't exactly the right inductance, the optimum padding position doesn't correspond with dial calibration."

"True enough," agreed Smithy. "But that's something I'll have to return to later. In the meantime, we have achieved two advantages. We've replaced a bulky air-cored oscillator coil with a smaller iron dust cored type, and we've replaced a variable padding capacitor with a fixed capacitor. On medium waves, the padding capacitance required is

usually of the order of 450pF, so the variable padding capacitor we've obviated is a relatively expensive and large compression component."

Smithy raised his mug to his lips and drained its contents. Fascinated, Dick watched a large piece of enamel flake off its surface and float to the floor.

"It looks," said Smithy, wiping his lips and glancing briskly at the Workshop clock, "as though we'll have to resume this discussion at our next little get-together. The clock says it's back to work now."

"Righty-ho," said Dick equably, taking his stool back to his own bench.

Smithy looked surprised.

"Aren't you going to ask for the loan of that signal genny after all?"

"I don't think so," replied Dick. "I'll restrain my impatience until we've had our next gen-session. After that I may not need it anyway!"

THREE TO ONE

Transistor Medium and Long Wave Tuner Unit

By A. S. Carpenter, A.M.I.P.R.E.

By taking advantage of the circuit up to and including the detector load on the popular Weyrad printed board type PCA1, it is possible to make a delightfully small and slim medium and long wave tuner unit. The unused section of the board provides a convenient mounting for the wavechange switch and the a.f. output components

IF YOU REQUIRE A SENSITIVE TUNER UNIT FOR USE with your tape recorder or amplifier, and one that really works well with no aerial or earth connected, then this article is for you. The project is an extremely simple one and the construction can be completed in about four hours flat—even if you have to use the kitchen table! The outcome is a neat and slim unit that will be in numerous stations over the medium and long wavebands.

Very few leads have to be connected due to use of the Weyrad printed circuit board type PCA1, on which practically all the work has already been done for you. This board was originally designed to accommodate a complete transistor receiver, but only the r.f. and i.f. circuits are required for our present purposes. We still use the remainder, however, as will be seen later.

The finished unit uses three transistors and a diode, and a signal generator is necessary for alignment due to the superhet technique employed. The tuner can be aligned without a generator, but this tends to be a rather tedious and chancy procedure.

The physical dimensions of the assembly are 9½ x 4½ x 2in (including control knobs) the only additional items needed being a battery and a short

piece of coaxial cable to enable an output connection to be made to the apparatus with which the unit is to be used.

The Circuit

Because this is a practical article a detailed discussion on the way the unit works will be omitted. The complete circuit is, nevertheless, shown in Fig. 1 and, here, everything to the left of the broken line is exactly as given in the printed board layout. The items added are to the right of the broken line and are only four in number since the battery is external. The battery may be either a 6 volt type such as the PP1, or a 7.5 volt type such as the AD43. As may be seen, T₁ (OC44) is a conventional mixer/oscillator whilst two OC45's function as intermediate frequency amplifiers. The diode acts both as signal and a.g.c. detector.

Mechanical Details

Before detailing actual construction it is convenient to consider the way in which the unit is held together and Fig. 3 gives the plan.

A panel (to which a dial is eventually pasted) is drilled with two holes through which the two control

Fig. 1. The circuit of the tuner

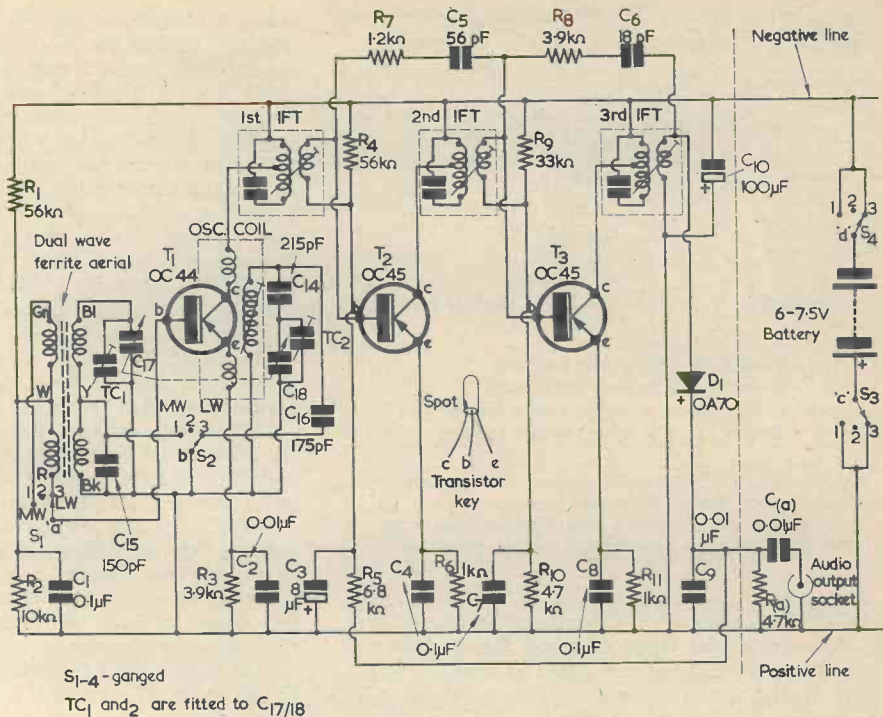

Components List

Resistors (all resistors 10% ¼ watt)

R ₁	56kΩ
R ₂	10kΩ
R ₃	3.9kΩ
R ₄	56kΩ
R ₅	6.8kΩ
R ₆	1kΩ
R ₇	1.2kΩ
R ₈	3.9kΩ
R ₉	33kΩ
R ₁₀	4.7kΩ
R ₁₁	1kΩ
R(a)	4.7kΩ

Capacitors (all fixed capacitors should be miniature types, with electrolytic components at 9V wkg, and paper components at 150V wkg. Omissions in suffix numbers are due to capacitors agreeing with the printed board)

C ₁	0.1μF
C ₂	0.01μF
C ₃	8μF electrolytic
C ₄	0.1μF
C ₅	56pF silver mica 5%
C ₆	18pF silver mica 5%
C ₇	0.1μF
C ₈	0.1μF
C ₉	0.01μF
C ₁₀	100μF electrolytic
C ₁₄	215pF silver mica
C ₁₅	150pF silver mica

C₁₆ 175pF silver mica (see text)

C₁₇, C₁₈ 208 + 176pF, twin-gang type "00", with centre screen and trimmers (Jackson Bros.)

C(a) 0.01μF

Coils, etc.

Oscillator coil P50/1AC
 1st i.f.t. P50/2CC
 2nd i.f.t. P50/2CC
 3rd i.f.t. P50/3CC
 Ferrite rod aerial RA2W
 Printed board PCA1

Weymouth
"Weyrad"

Semiconductors

T₁ OC44
 T₂, T₃ OC45
 D₁ OA70

Switch

4-pole 3-way miniature rotary

Control Knobs

1 1in dia., gilt centred
 1 2½in dia., transparent plastic with cursor line

Miscellaneous

Battery, PPI or AD43 (see text)
 Coaxial output socket, surface mounting
 2 plastic clips for ferrite rod, ⅜in dia., Lektrokit LK-2851
 Panel material, 9¼ x 4¼ x ½in

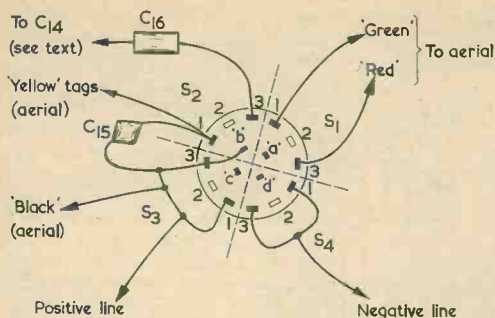

Connect tag 'a' to T_1 base (see text)
 Connect tag 'b' to black tag on aerial
 Connect tag 'c' to lead to battery Positive
 Connect tag 'd' to lead to battery Negative

Fig. 2. Details of the switch wiring. The constructor should check the outer contacts corresponding to poles a, b, c and d before wiring, as orientation with some switches may be different to that shown here

spindles pass when the PCA1 board is placed over it. Two channelled strips of wood then engage the board at either end and are glued in position to the inside of the panel. When dry the assembly may be turned over whereupon, with the dial and control knobs fitted, it is ready for use. The reader may then either make up a slim casing or let the unit lie flat in a "well" cut out in an equipment cabinet.

Assembly

Note: When fitting resistors and capacitors to the board do not adopt a "spot soldering" technique. Bend the lead-out wires over by about $\frac{1}{8}$ in and then solder to avoid bad joints.

(1) Commence by fitting C_{17} , C_{18} in the space marked for them, and checking that neither of the bolt heads fouls the negative line. Fit the i.f. transformers, noting that the third one differs in type from the other two. Also fit the oscillator coil but, before soldering in position, make certain the red spot painted on it agrees with the instruction printed on the board (see also Fig. 4).

(2) Fit the rotary switch in the hole provided originally for a volume control.

(3) Fit a coaxial output socket as shown in Fig. 4, using either 8BA nuts and bolts or enlarging the holes to take 6BA types.

(4) Solder a link wire between the two holes marked "R20". This will connect the output socket casing to the positive line. Check the printed wiring to ensure that this connection is correctly made.

(5) Solder in all resistors where indicated on the board up to and including R_{11} .

(6) Solder in all capacitors where marked on the board up to and including C_{10} , ignoring all + and - signs except for C_3 and C_{10} , which observe.

(7) Enlarge slightly the hole provided for D_1 + and insert in it the red lead of the diode together with one lead of $R_{(a)}$. Solder both to the board

using a heat shunt for the diode. Also solder the negative lead of the diode as indicated.

(8) Solder the free end of $R_{(a)}$ to $C_{10}+$.

(9) Locate the hole originally provided for the volume control tag nearest the edge of the board (see Fig. 4) and solder in one lead-out wire of $C_{(a)}$.

(10) Locate the hole marked "A" near the output socket and solder in the free end of $C_{(a)}$. Also solder a short lead therefrom to the output socket centre tag. Ensure that the copper at hole "A" does not connect to any of the circuit as now used.

(11) Fit C_{14} where marked on board (see Fig. 4) close to the oscillator coil, checking that it does not foul the metal can.

(12) Wire the switch to agree with Fig. 2, connecting the tags marked "positive line" to the link wire in the "R20" position.

(13) Locate the hole provided for "R13" nearest the edge of the board and check that it is in contact with $C_{10}-$, already fitted. Solder a wire therefrom to S_4 where marked "negative line" (Fig. 2).

(14) Fit C_{16} and anchor one end by using the hole marked "B" on the board and in Fig. 4. It should be noted that it might be necessary to modify the value of this capacitor slightly later. Ensure that the copper at hole "B" does not connect to any of the circuit as now used.

(15) Run a lead from hole "B" to C_{14} (already fitted) on the copper side of the board.

(16) Solder in transistors T_1 , T_2 , T_3 exactly as marked on the board. Use heat shunts.

(17) Locate a small hole between "E" and "B", T_1 (see Fig. 4) and run a lead from this point to S_1 , tag (a). Check the copper circuit to ensure that the connection at this hole is common to the base of T_1 .

(18) Fit the aerial as shown and wire to agree with Figs. 2 and 4. Metal clips must *not* be used to retain the ferrite rod. Note the connection from the white tags on the aerial to a small hole adjoining R_1 (which should be common to the junction of R_1 and R_2). It is advisable to allow sufficient slackness in the inter-coil connecting leads to allow movement of the coils along the rod.

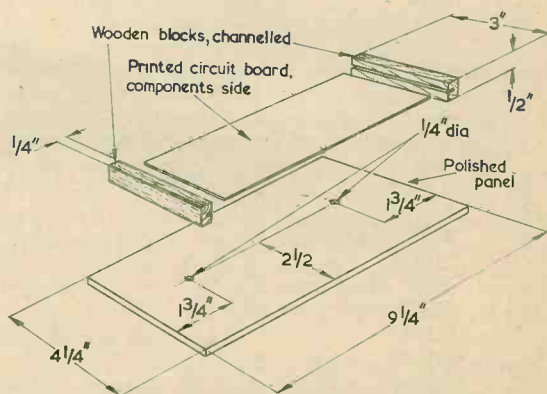

Fig. 3. How the printed board is assembled to the front panel

Link white tags and connect as shown

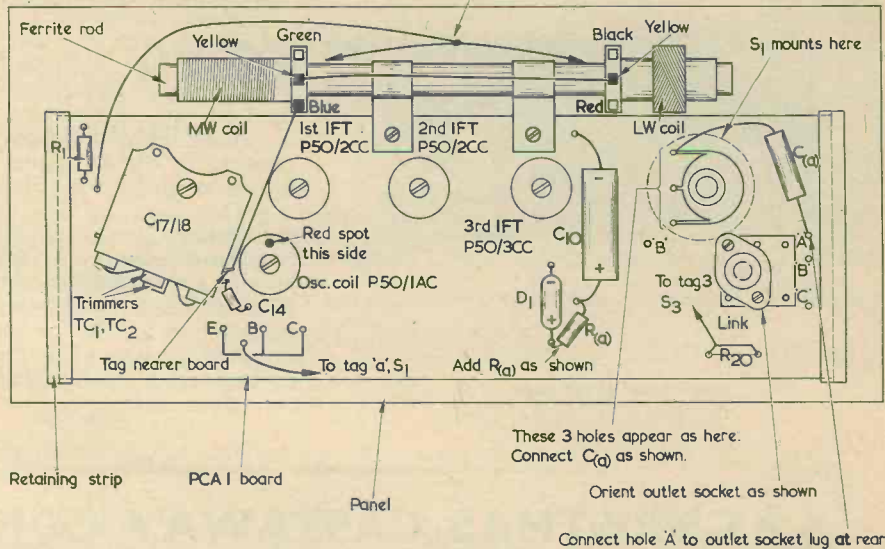

Fig. 4. The general layout, together with additional wiring and components

(19) Fit suitable stud or plug connectors to the appropriate battery leads coming from the switch, observing polarity.

This completes the wiring and, after checking for correct connections and performance, place the board in position and secure it to the panel as described earlier. When dry fix the dial and control knobs. It should be noted that, during assembly and checking, most of the printed circuit can be followed by holding the copper side of the board up to a strong light.

Alignment

(1) With the unit connected to an amplifier, and with a battery fitted, switch on and set the switch to position "1". Rotate the tuning capacitor to fully enmesh the vanes. Bring a lead carrying modulated signals at 470 kc/s from a signal generator close to the aerial and carefully adjust the cores of the i.f. transformers (commencing with the third and working backwards) for maximum signal either aurally or with a suitable visual aid connected. Core settings tend to be critical, so always use the lowest detectable signal to prevent the a.g.c. system from masking results and to avoid overloading. If no signal is heard initially, inject the generator output, suitably attenuated and via a blocking capacitor of $0.01\mu\text{F}$, between the positive line and the base feed potentiometers of T_2 and T_3 (i.e. at the junctions of R_9 and R_{10} , and of R_4 and T_5).

(2) Set the generator to 600 kc/s and with the tuning capacitor vanes very nearly closed carefully tune in the signal using the oscillator coil core. The core position is critical and will normally be almost at the top of the can. Roughly set the medium wave coil on the ferrite rod for maximum signal.

(3) Adjust the generator to 1,500 kc/s, almost fully disengage the tuning capacitor vanes and tune in the signal with TC_1 and TC_2 . These trimmers peak sharply and require careful adjustment.

(4) Repeat (2) and (3) above several times, then seal the medium wave coil in position with Sellotape when no further improvements can be made.

(5) Rotate the switch to position "3" and set the generator to 200 kc/s. Rotating the tuning capacitor should resolve the signal when the vanes are 50 per

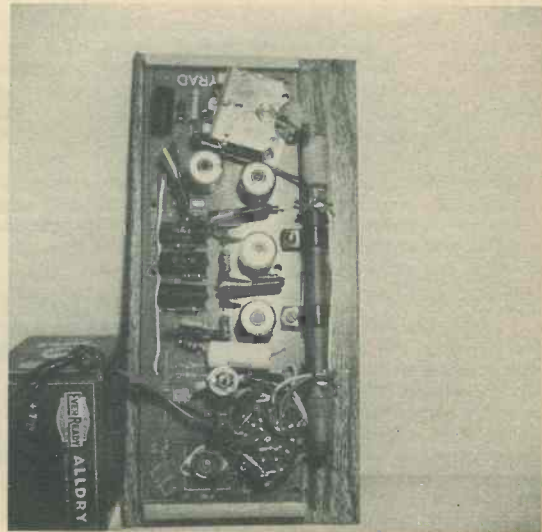

The completed tuner unit. Compare with Fig. 4 above

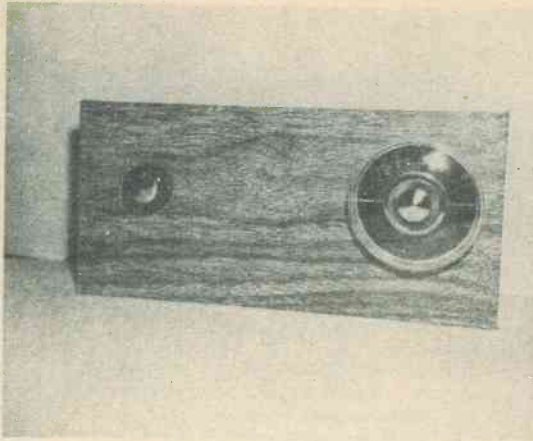

Front panel of the tuner

cent enmeshed. Small capacitor values—say 20pF—across C_{16} may help here, especially if the signal is received at the end of the scale.

If quick results are required use a trimmer in conjunction with C_{16} and replace it with a fixed component later after making a measurement of the correct value. Finally seal the long wave coil in position and remove the generator, whereupon broadcast signals should romp in. It is then permissible to slightly detune the second i.f. transformer to broaden the response.

Conclusion

After completion of this work, you will now possess a remarkably sensitive little tuner that will be most useful for tape recording purposes or for feeding into a valve or transistor amplifier. You can even use it as a low power headphone receiver by connecting a pair of high impedance phones to the output socket!

CHRISTMAS CASTAWAY CONTEST



Results and Prize-Winning Entry



In our Christmas Castaway Contest, details of which were given in the last December issue, we asked readers to send accounts of how they, themselves, would act if they were cast away upon the highly improbable desert island of Transistiana. This island, as readers will recall, possesses a fully equipped workshop with a power supply socket giving 240 volts a.c. at currents up to 50 amps. Castaways were allowed to have as many components as could be stored in a crate having internal dimensions of 4 x 3 x 2ft, and it was stated that there was no point in contacting ships or aircraft in an attempt at rescue, as the island was so situated that no ship or aircraft has yet been able to discover it. We pointed out also that humour would not be at all out of place.

We had anticipated that quite a number of entries would be in fairly serious vein with only an interlarding of humour, but it so happened that practically all contestants concentrated entirely on the humorous approach. Some of the humour was, indeed, very way-out! This reaction is probably because we made the conditions on the desert island a little too difficult, but it does not, of course, detract from the success of the competition.

The winner of the 10 guinea cheque and the 5 guinea book voucher is J. Leavis (London), and his prize-winning entry—which contains more atrocious puns per paragraph than we have seen for many a long year!—appears here.

Whilst we don't feel that they were quite good enough for publication, we would also like to mention the entries submitted by W. B. Glayzer (Swindon), J. R. Squires (California, U.S.A.) and A. E. Prowse (London). Mr. Glayzer concentrated on a science-fiction approach in which, by virtue of "controlled orbit generators", he first of all materialised on the island and, secondly, re-materialised in a friend's shack by way of the loudspeaker. Mr. Squires found that his crate was packed with tiny micro-electronic binary flip-flop solid state modules manufactured by Texas Instruments. Such modules are currently being made, incidentally, and his crate contained 21,233,664 of them. When last heard of, he was still attempting to solder these up into a vast computer! Mr. Prowse underwent quite a few weird adventures, including the setting up of a production line for transistor radios which were paid for by the local natives with back numbers of *The Radio Constructor*. Despite the fact that we are not publishing these entries, we are sending their authors cheques for 2 guineas plus 2 guinea book vouchers.

We would also like to thank all other competitors, both for their interest and for their keenness in submitting entries.

Letter found in a Bottle (6V6) washed up at Westminster Pier

By JOHN LEAVIS

I've been here now for nearly two years, and yet it seems like only yesterday when it all happened. One minute I was diving in at Westgate-on-Sea and finding a ship underneath, and the next, I was floating up the lagoon on that box. Imagine my surprise when I found it to be full of electronic components. When I found the hut, fitted out as a workshop, I had everything I needed for survival in style.

The first apparatus constructed from the contents of the box was the lagoon-water purification unit, Fig. 1, to provide drinking water.

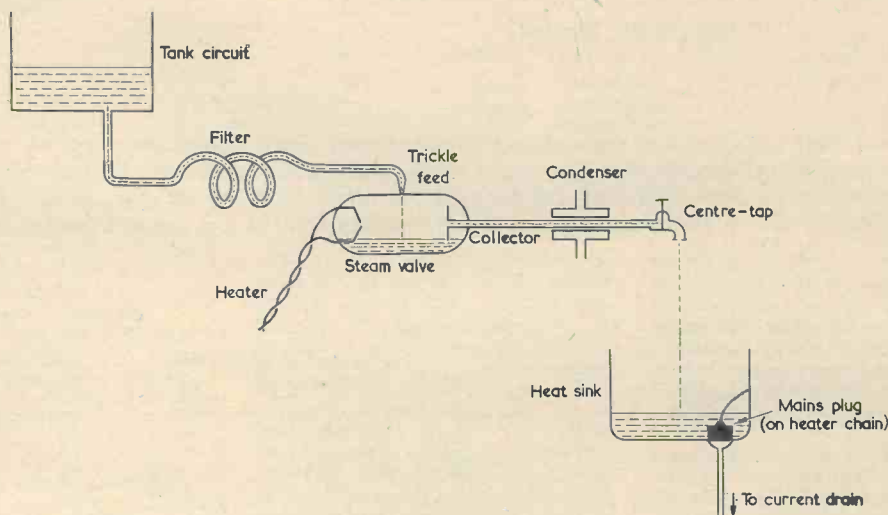

Fig. 1. Lagoon water distilling plant

Next I turned my attention to food. An old TV chassis provided me with yokes, cores and biscuits, which I cooked in a crystal oven, and served on dish reflectors. The island has an abundance of magnetic fields suitable for the cultivation of electric currents, although some have unsatisfactory gates. For liquid refreshment I use a bus-bar.

Transport is no problem, it being a matter of minutes to set up a complete tube system in a suitable cavity. The tube itself runs on lecher lines, with test points and a buffer at each junction. Coaches are Class A, Class B and Class C, although push-pull is necessary on peaks. Wheatstone bridges are used to cross ravines.

As for sea travel, the abundance of carrier waves makes surfing seem child's play, and work is now beginning on a clipper. In case of flood an arc has been struck, this being a major achievement due to the high resistance of gofer wood.

Of course, this life is not without its drawbacks; I always carry an electron gun, for fear of meeting one of the 625 lions, and I keep a battery ready charged at the hut. For musical relief I use a wave band, and I obtain hours of harmless fun from a short-wave receiver with 40 meters marked as "AMATEUR".

THE TELEVISION SOCIETY'S SILVER MEDAL AWARD

The Television Society announces that in future two Silver Medals will be presented annually for outstanding artistic achievement in television.

It is anticipated that one Medal will be awarded to an artist for outstanding artistic achievement in front of the camera and the second Medal will be presented for outstanding artistic achievement in television behind the camera.

The next presentation of these awards will be made at the Society's Annual Dinner and Dance on Friday, 8th May, 1964, at the Dorchester Hotel in London and the names of the recipients for this year will be announced for release on that date.

3-Transistor V.H.F. Receiver

by D. M. Bussell

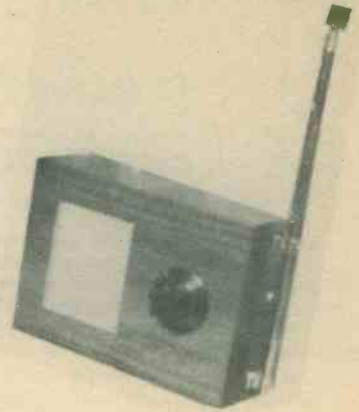

This completely self-contained super-regenerative receiver, whose cabinet measures $4\frac{7}{8} \times 3\frac{1}{2} \times 1\frac{3}{8}$ in only, offers loudspeaker reception on the v.h.f. bands. Although it was originally designed for the 2-metre amateur band (144-146 Mc/s) it can cover—with the aid of a simple optional modification—80 to 160 Mc/s, a range which includes Band II and aircraft frequencies

THE RECEIVER DESCRIBED IN THIS article was originally intended for the 2-metre amateur band but, on completion, it was found to give good reception between 80 and 160 Mc/s, which includes aircraft control bands as well as amateur transmissions. In areas of good signal strength, B.B.C. f.m. transmissions on Band II may also be received. The f.m. signals are discriminated on the skirts of the tuning response offered by the receiver.

The Circuit

The circuit of the receiver appears in Fig. 1, and it will be seen that the first stage functions as a superregenerative detector, thereby enabling a very high sensitivity to be achieved with relatively few components. The feedback capacitor, C_5 , is that provided by a pair of twisted insulated wires and is adjusted for best reception conditions. The capacitance offered here is of the order of 1 to 2pF. Transistor TR_1 is brought to its optimum operating point by means of VR_1 , which also functions as a volume control.

The prototype employed a Texas Instruments 2G403 in the TR_1 position. Also tried were an AF115 and an OC171. These were satisfactory, but not quite as "hot" as the 2G403.

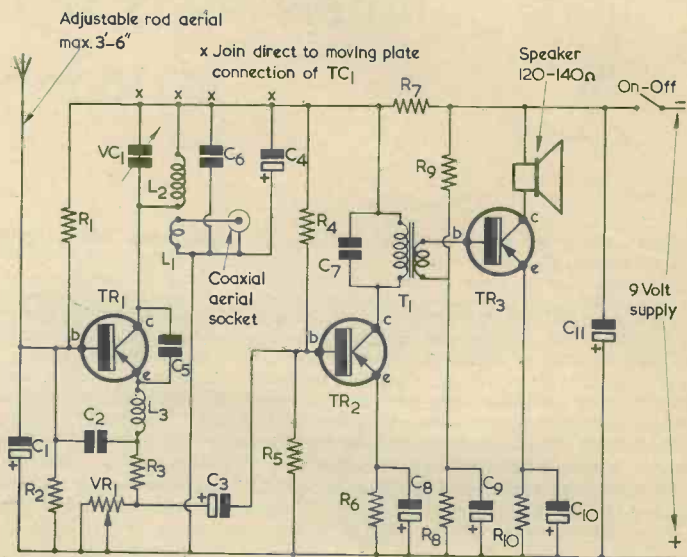

All wiring in this section should be as short and direct as possible. Connect C_6 and C_4 from the junction of VC_1 and L_2 to positive line

Fig. 1. The circuit of the 3-transistor receiver. The on-off switch is ganged with VR_1

A rod aerial is fitted for use in areas of good signal strength.* Alternatively, an external dipole may be employed, this being connected to the receiver by way of 75Ω coaxial cable. Of the three coils, L₁ is the dipole coupling coil and L₂ the signal tuned coil, whilst L₃ is an r.f. choke.

Components List

Resistors

(All fixed resistors ¼ watt 10%)

R ₁	22kΩ
R ₂	4.7kΩ
R ₃	1.2kΩ
R ₄	33kΩ
R ₅	10kΩ
R ₆	1kΩ
R ₇	100Ω
R ₈	1.5kΩ
R ₉	8.2kΩ
R ₁₀	100Ω
VR ₁	5kΩ linear potentiometer with switch. Edge adjustment (optional).

Capacitors

C ₁	8μF electrolytic 6V wkg.
C ₂	0.005μF disc ceramic
C ₃	8μF electrolytic 6V wkg.
C ₄	25μF electrolytic 12V wkg.
C ₅	Twisted pair (see text)
C ₆	100pF ceramic
C ₇	0.002μF disc ceramic
C ₈	50μF electrolytic 6V wkg.
C ₉	50μF electrolytic 6V wkg.
C ₁₀	50μF electrolytic 6V wkg.
C ₁₁	200μF electrolytic 12V wkg.
VC ₁	5pF variable

Inductors

L _{1, 2, 3}	For details see text
T ₁	4.5:1 interstage or driver transformer, centre-tapped secondary. Only half of secondary is used

Transistors

TR ₁	2G403, OC171, AF115 (see text)
TR ₂	GET114, OC71
TR ₃	OC72

Speaker

3in speaker, 120-140Ω impedance. (Alternatively, use 3Ω speaker with 9:1 output transformer, such as Radiospares type T/T4)

Battery

9 volt battery. Every Ready type PP3, and connectors

Miscellaneous

Telescopic aerial, max. length 3ft 6in
2 Terry clips for aerial
Ferrite rod, optional (see text)
Flush-mounting coaxial socket
Tagstrips, cabinet, knob, speaker fabric, etc.

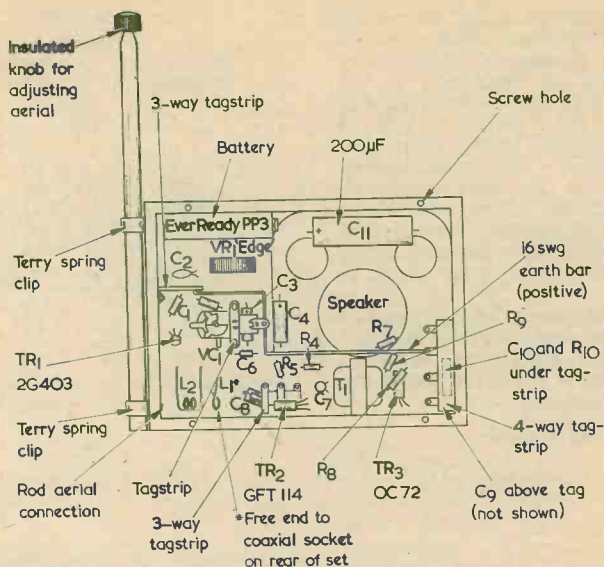

Fig. 2. The general layout inside the cabinet. Inside dimensions are 4½ x 3½ x 1½in

VC₁ has the relatively low capacitance of 5pF, and this enables tuning to be carried out without the necessity of a slow motion drive. It should be noted that the moving vanes of VC₁ are at the negative supply potential, thereby providing a tuned circuit with very short interconnecting leads. To extend the frequency range, a ferrite rod may be inserted into L₂, and details of this are given later. The use of the ferrite rod is optional.

In the prototype, VR₁ is a miniature potentiometer intended for edge adjustment, the edge protruding through a slot in the rear of the cabinet. A miniature potentiometer with spindle adjustment may be employed in its place, if desired.

The output from TR₁ is fed, via C₃, to a fairly conventional transformer-coupled a.f. amplifier. TR₂ is a GET114 or OC71, and it drives the output transistor TR₃ by way of T₁. This last component is a 4.5:1 interstage or driver transformer using half of the secondary winding only.

TR₃ is an OC72 and it feeds directly into a 3in loudspeaker

having in impedance of 120-140Ω. If it is desired to employ a 3Ω speaker, this may be used in conjunction with a 9:1 output transformer.

Coils

The coils are home-wound. The r.f. choke, L₃, consists of approximately 22in of 35 s.w.g. enamelled wire wound in a single layer on a former having a diameter of ¼in. The turns should be as close together as possible. L₂ consists of 6½in of 16 s.,w.g. tinned copper wire wound three times around a ⅜in diameter former, which is then removed. The turns are spaced by the diameter of the wire. About 1in of wire should be free at each end for subsequent connection across the tuning capacitor VC₁. L₁ consists of one turn of the same wire and on the same diameter former as L₂, the former being removed afterwards. Details of the positioning of L₂ are given later.

Construction

The complete receiver is housed in a wooden cabinet having internal dimensions of 4½ x 3½ x 1½in. The positioning of the components is illustrated in Fig. 2, and it will be noted that the assembly is extremely compact. Most of the parts are mounted on a 4-way tagstrip at the speaker end of the cabinet, a 3-way tagstrip on the base, and a 3-way tagstrip at the aerial end. An earth busbar, common to the positive

* It will be noted that the rod aerial is connected to the base of TR₁, which is bypassed to the positive supply line by the electrolytic capacitor, C₁. Signal pick-up is still feasible, however, as C₁ may have a significant impedance at v.h.f. It is also possible that the rod aerial functions partly as a counterpoise to the r.f. wiring in the receiver itself.—Editor

supply, connects to the second tag down on the 4-way tagstrip, to the tag at the speaker end of the 3-way tagstrip on the base, and to the rearmost tag on the remaining 3-way tagstrip. The busbar consists of 16 s.w.g. tinned copper wire. The variable resistor VR_1 is mounted by soldering the tags connecting to its slider and the earthy end of its track to the busbar. Also soldered to the busbar is a further tagstrip which is shown in more detail in Fig. 5.

Fig. 3 illustrates the rear panel of the cabinet and illustrates the slot needed for adjustment of VR_1 . Also shown is the coaxial socket for connection to L_1 .

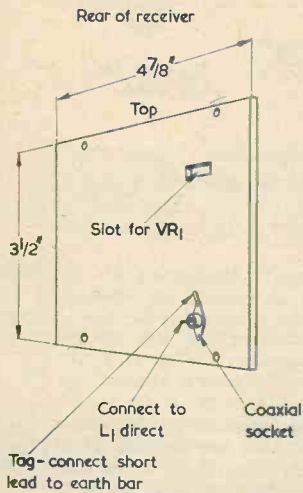

Fig. 3. The rear panel, showing the slot for VR_1 and the coaxial socket

Construction should commence with the a.f. stages, the components from R_4 and R_5 up to the speaker being wired as shown in Figs. 4 (a) and (b). For clarity, the 4-way tagstrip is omitted in Fig. 4 (a), thereby enabling the position of components below this tagstrip to be shown. The tagstrip and its associated components then appear in Fig. 4 (b). Capacitor C_9 , shown in dotted line, is, actually, to the rear of the tagstrip.

The a.f. stages should be wired following the layout of Figs. 4 (a) and (b) and carefully observing the circuit diagram of Fig. 1. Electrolytic capacitors must be wired with correct polarity, and a heat shunt used when connecting up the transistors.

The a.f. stages may be tested when completed. After checking the

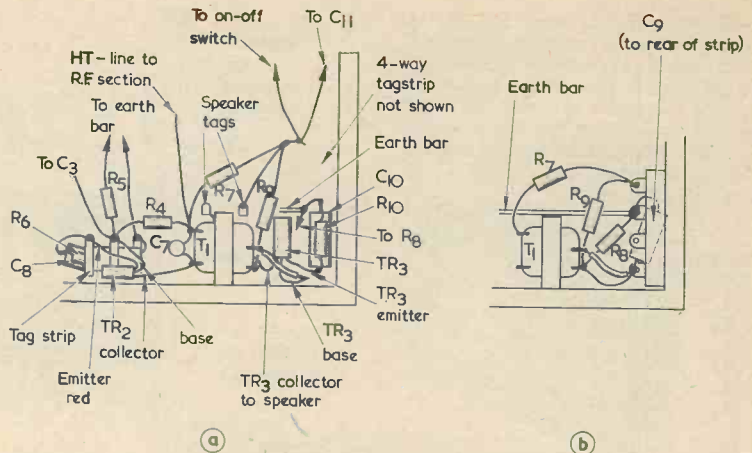

Fig. 4 (a). Wiring up the a.f. stages.
(b). The components around the 4-way tagstrip

wiring against the circuit diagram, temporarily connect the negative lead-out of C_3 to the junction of R_4 and R_5 . If a low impedance earpiece or headphone is available, this should be connected between the positive lead-out of C_3 and the positive supply line. The earpiece will now function as a microphone and, if tapped, should cause a resultant signal to be heard from the speaker. If a low impedance earpiece is not available, a faint hum will be heard (assuming the usual mains wiring in the vicinity) if the positive lead-out of C_3 is touched with the finger.

The detector stage is next wired up, following the layout given in Fig. 5 and carefully checking, all the time, against the circuit diagram

of Fig. 1. The twisted pair, C_5 , consists of about 2in of narrow gauge insulated wire twisted together as shown, one wire connecting to the emitter of TR_1 and one to the collector. The rod aerial connects into circuit by way of the lower Terry clip. The connection between this clip and the base of TR_1 must be as direct as possible.

The shield lead-out of TR_1 should be connected to the earth busbar.

The coupling coil, L_1 , has one lead-out wire connected to the earth busbar and the other to the central tag of the coaxial socket on the rear panel of the receiver. When all connections are made and the rear panel is fitted, L_1 should be spaced from L_2 by $\frac{1}{4}$ in. Also, the

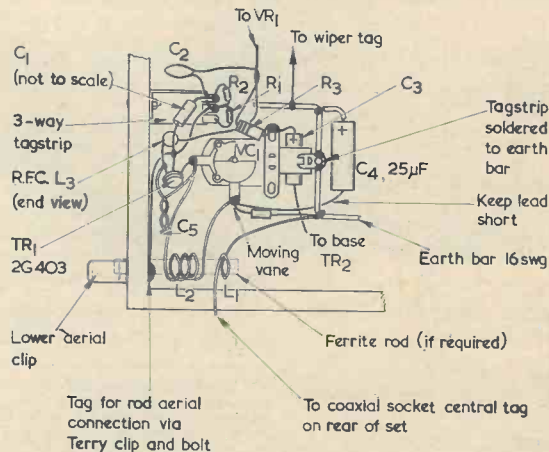

Fig. 5. The layout around TR_1 . All wiring here must be as short and direct as possible

two coils should be so positioned that a ferrite rod can be slid into them through the side of the cabinet, as in Fig. 6.

A 1-way tagstrip is soldered to the earth busbar as illustrated in Fig. 5. The tag on this strip carries the connections at the positive end of C_3 .

When wiring up the r.f. stage, care should be taken to ensure that electrolytic capacitors are connected with correct polarity. All wiring must be short and direct, and a heat shunt should be used when connecting the transistor.

The completed cabinet should have the appearance shown in Fig. 6. The dimensions given here agree with the internal dimensions quoted for Fig. 3 when $\frac{3}{8}$ in wood is used for the sides and top and $\frac{1}{2}$ in wood for the front panel. The manner in which the edge control of VR_1 protrudes through the rear panel is clearly visible here. Also shown is the hole in the side of the cabinet through which the ferrite rod is passed.

Operating the Receiver

On completion of wiring and final checking, the receiver may be tested. A battery should be connected and the receiver switched on. If VR_1 is adjusted a hissing noise should become audible, this indicating that the detector is operating correctly. VR_1 should be adjusted for maximum noise. When a station is received the hiss level will drop, and modulation should be heard. The telescopic aerial is then adjusted for maximum output, bearing in mind that it should not be

held with the bare hand as this will reduce sensitivity. Finally, the twisted wire capacitor, C_5 , should be adjusted for best results at all positions of VC_1 , adjusting VR_1 for maximum output. When the correct capacitance has been found, C_2 should be sealed with insulating tape.

For reception of lower frequency signals, a ferrite rod is inserted through the hole in the side of the cabinet. The rod should have a diameter of $\frac{3}{8}$ in and sufficient length to enable it to pass fully into L_2

and L_1 whilst still being capable of being gripped outside the cabinet. With the rod fully inserted, signals at frequencies in the range of 80 to 100 Mc/s should be obtained, frequency increasing as the rod is progressively removed. For 140 to 160 Mc/s, the rod is not required. The permeability and type of rod is experimental, "yellow grade" being employed in the prototype.

When the receiver is functioning correctly, consumption from a new 9-volt battery will be slightly in excess of 10mA.

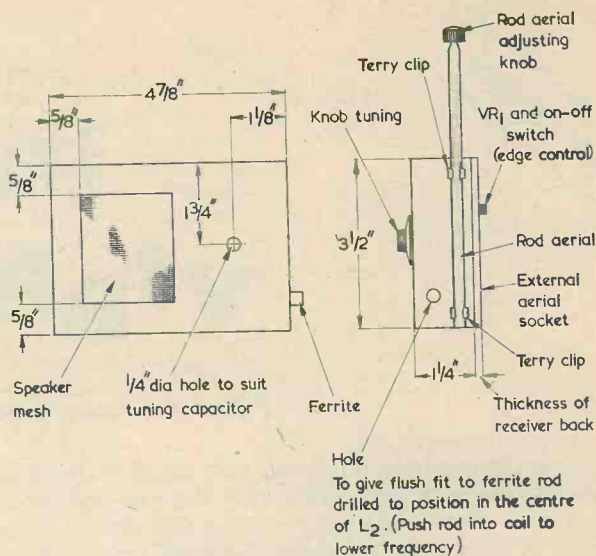

Fig. 6. External details of the cabinet

Radio Aids in New Universal Bulk Ship

A comprehensive range of Marconi Marine communications equipment and radio aids to navigation has been installed in the new universal bulk ship *Carlton*, 20,386 tons deadweight.

Built at Sunderland by Short Brothers Ltd., for Chapman and Willan Ltd., Newcastle, the *Carlton* employs an "Oceanspan VI" transmitter with an "Atalanta" receiver for worldwide communication by radiotelegraphy on medium and high frequencies.

The emergency equipment comprises a "Salvor" medium frequency transmitter, an "Alert" guard receiver, an "Autokey" automatic keying device and the new "Lifeguard" auto-alarm, all mounted in an auxiliaries rack. An "Argonaut" v.h.f. transmitter/receiver will provide short range radiotelephone communication, while a "Lifeline" portable survival craft radiotelegraph transmitter/receiver is supplied for use in the vessel's lifeboats.

The radar chosen for this new vessel is a "Radiolocator IV"; and other aids to navigation include a "Seagraph III" high-power recording echometer and a "Lodestone IV" direction finder.

Carlton is the first universal bulk ship to be built in Britain.

Transistorised VIBRATO Unit

By Peter A. Roe, Grad.I.E.E.

This article describes a vibrato unit which is completely transistorised, provides virtually distortion-free sine wave modulation, and has continuously variable depth and speed controls. Apart from its immediate applications with electrical and electronic musical instruments, the design employs a diode modulator circuit which offers many potential uses in wider fields

THE WRITER HAS FOR SOME TIME REQUIRED A self-contained vibrato unit for use with an electric guitar which could be introduced between the guitar and any amplifier (in the writer's case a 5 watt battery powered amplifier) without the need for external power supplies. There are many vibrato units and circuits available but almost invariably they use valves and require an external h.t. and heater supply. The unit developed by the writer is, however, transistorised and consumes a relatively small current (about the same as a pocket radio) so that the unit can be made quite small and be powered by a couple of small batteries. The depth of vibrato is continuously variable from 0 to 100% and the speed is variable over about 2 c/s to 10 c/s.

Principle of Operation

The vibrato effect is produced by amplitude modulating the audio frequency signal from the guitar pick-up with a low frequency signal obtained from a sine wave oscillator. The modulator section of the unit is built around a simple diode modulating element and the low frequency sine wave is obtained from a phase shift oscillator.

Transistor modulators operating at radio frequency usually use transformers or tuned circuits to couple the carrier and modulating signals to the modulator, but in the case of the vibrato unit the carrier is the audio frequency signal from the pick-up, and the modulating signal is only a few cycles per second. Clearly a tuned circuit in the modulating signal circuits would require impractically large value components (typical values would be, roughly, 100H and 1 μ F at 10 c/s). The writer has overcome this difficulty by developing a simple junction diode design which completely eliminates the use of transformers and tuned circuits.

By suitable choice of components the modulator section is capable of satisfactory operation over a very wide range of applications, of which the vibrato unit described here represents just one typical example.

The Basic Modulator Element

The basic modulator arrangement is shown in Fig. 1, and it consists of an a.c. voltage divider

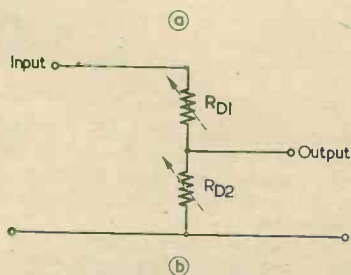
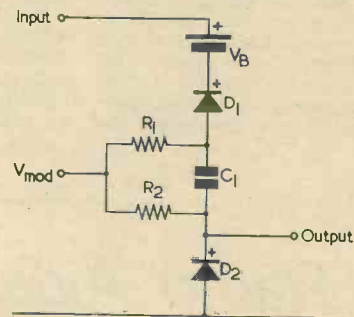

Fig. 1 (a). The basic modulator circuit
(b). The a.c. equivalent of the modulator circuit.
 R_{D1} and R_{D2} are the dynamic resistances of D_1 and D_2

formed by D_1 , C_1 and D_2 . Both diodes are biased in the forward direction by the bias voltage V_B , which is about -12 volts. The forward current through D_2 depends upon V_{MOD} and the value of R_2 , and the forward current through D_1 depends on the difference between V_B and V_{MOD} and the value of R_1 . A diode biased in the forward direction behaves as a non-linear resistor and the resistance at any particular forward current (called the slope resistance or dynamic resistance) depends upon the forward current. A typical diode characteristic is shown in Fig. 2 and, as can be seen, the slope of the characteristic and hence the dynamic resistance varies over quite a wide range. The dynamic resistance can, in fact, be shown to be inversely proportional to the forward current over a range of about $5\mu A$ to a few milliamps. Using this fact and some simple algebra it can be shown that the voltage divider action of D_1 , C_1 and D_2 is directly proportional to $(V_B - V_{MOD})$ and this is a condition for linear amplitude modulation of the input signal.

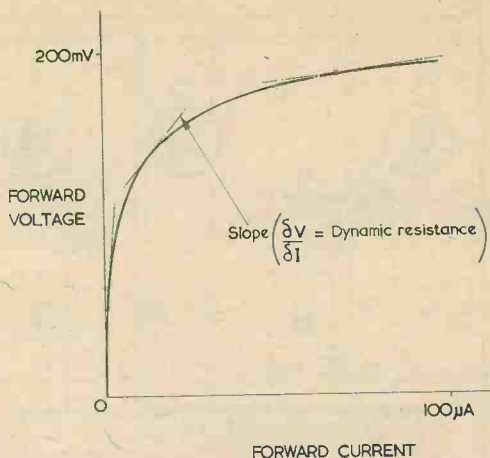

Fig. 2. A representative diode characteristic

In order that the modulation shall be linear and free from distortion there are several conditions which must be fulfilled in order to justify its use. They may be summarised as follows.

(1) The modulating current through the diodes must be proportional to the modulating voltage, which means that R_1 , R_2 must be much larger than the d.c. resistance of the diodes. A typical value for R_1 , R_2 is $47k\Omega$.

(2) The current driven through the diodes by the carrier signal must be much smaller than the modulating current. This imposes a limit of about $50mV$ (r.m.s.) on the carrier signal that can be used.

(3) The impedance of the capacitor C_1 must be small at the carrier frequency so that the modulation depth is independent of frequency, but the impedance of C_1 must be large at the modulating frequency so that the modulating current is not shunted away from the diodes. Obviously C_1 can only have one value at a time and so the carrier frequency must be much higher than the modulating frequency to satisfy this condition. A satisfactory figure would be a carrier frequency of at least 10 times the modulating frequency. There is also an optimum value of C_1 since a compromise must be reached, and the criterion for this is that the impedance of C_1 at the minimum carrier frequency is between 350 and 450Ω . Fig. 3 is a graph showing the optimum value of C_1 for various carrier frequencies.

(4) The carrier signal must have a low source impedance below about 180Ω in order to ensure that the variable loading produced by the change in diode resistance does not affect the carrier voltage.

(5) The output impedance of the modulator is fairly high, and the minimum output load that can be used is about $47k\Omega$.

(6) A large modulating signal is required for high modulation depth. For 100% modulation the peak to peak modulating voltage must equal V_B , which is about -12 volts.

Provided that all these conditions are observed good quality modulation up to about 90% can be obtained with any carrier from 50 c/s to over 1 Mc/s using any modulating signal from d.c. upwards. The distortion of the carrier is very low, less than 1%, and the modulating signal less than 5%. All of these limitations can be exceeded if an increase in distortion and non-linearity can be tolerated.

The Vibrato Unit

The vibrato unit utilises an audio frequency version of the basic modulator element together with appropriate buffer stages and a phase shift oscillator to supply the modulating signal.

The complete circuit is shown in Fig. 4. The

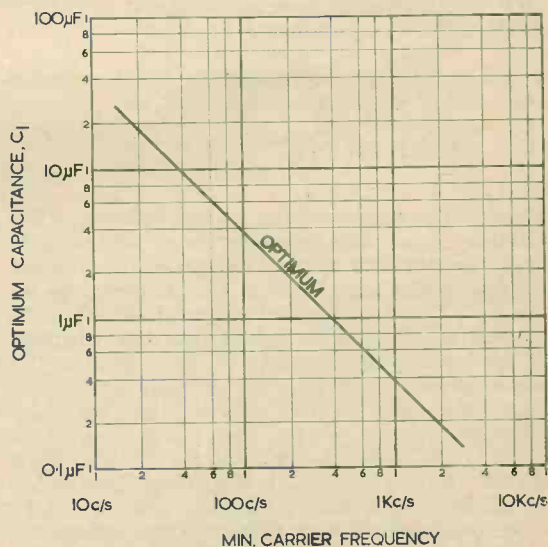

Fig. 3. Graph showing optimum values of capacitance against minimum carrier frequency

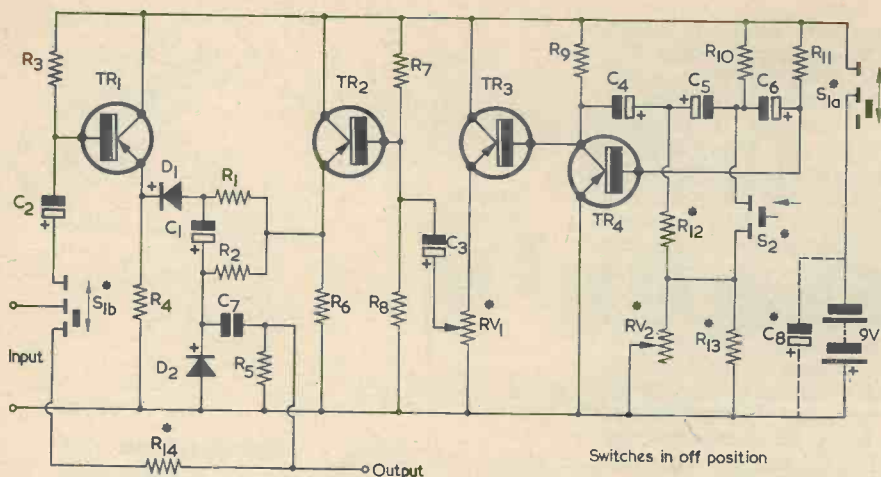

Fig. 4. Circuit of the complete vibrato unit. The components marked with an asterisk are not mounted on the circuit board

Components List

Resistors (all fixed resistors 10% $\frac{1}{2}$ watt)

R ₁	47k Ω
R ₂	47k Ω
*R ₃	180k Ω
R ₄	4.7k Ω
R ₅	47k Ω
R ₆	4.7k Ω
*R ₇	12k Ω
R ₈	10k Ω
R ₉	2.7k Ω
R ₁₀	5.6k Ω
*R ₁₁	680k Ω
*R ₁₂	2.7k Ω
*R ₁₃	100k Ω
R ₁₄	10k Ω
RV ₁	2.5k Ω potentiometer, lin track
RV ₂	25k Ω potentiometer, lin track

Capacitors (all capacitors except C₇ are electrolytic)

C ₁	4 μ F 15V wkg
C ₂	8 μ F 15V wkg
C ₃	100 μ F 25V wkg

C ₄	1 μ F 15V wkg
C ₅	1 μ F 15V wkg
C ₆	1 μ F 15V wkg
C ₇	0.047 μ F
*C ₈	250 μ F 25V wkg

Semiconductors

TR _{1, 2, 3}	OC71 or similar
TR ₄	OC75, GET102, OC202*
D _{1, 2}	OA5, OA81, OA90

Switches

S ₁	d.p.d.t. slide switch
S ₂	s.p.s.t. press switch

Batteries

2 PP4 batteries

Miscellaneous

Printed circuit board, case, plug, socket, knobs, etc.

* See text for further details.

carrier buffer consists of an emitter follower, TR₁, biased by R₃ so that its emitter is at -12 volts to supply the forward biasing voltage for the diodes. The modulating signal buffer, TR₂, is biased by R₇ and R₈ to give an emitter potential of -6 volts (i.e. half of TR₁ emitter voltage) so that, when an a.c. modulating signal is applied, the voltage to the diode modulator varies symmetrically about this centre value and, for 100% modulation, varies by ± 6 volts.

The lowest frequency likely to be obtained from a guitar is 80 c/s (Bottom E is 82 c/s) and by reference to Fig. 3 the capacitor C₁ has been chosen as 4 μ F. If the vibrato is to be used with any other instrument the lowest fundamental produced by the instrument must be determined and a suitable value of C₁ selected from Fig. 3. The leakage current of this

capacitor flows, in the main, through the diodes D₁ and D₂ and so must be very small, less than 10 μ A in fact. The leakage current in electrolytic capacitors, especially miniature types, varies quite considerably with type and age, etc., and so old or suspicious components must not be used in this position. A new component with a voltage rating of at least 15 volts is recommended for C₁.

The diodes used were actually Mullard OA5's but almost any germanium diode with a low reverse current can be used. The "driving" resistors R₁ and R₂ are 47k Ω , 10% tolerance components.

The output is taken from D₂ via C₇ and R₅, which are chosen to start cutting off at about 100 c/s and so help filter out the unwanted modulating signal, a small part of which (about 150mV) appears across D₂ together with the required modulated

output.

The modulating oscillator is of the phase shift type built around a single high gain transistor TR₄. The phase shifting network consists of three RC sections, of which one, RV₂, is variable in order that the frequency of oscillation may be controlled. (R₁₂ and R₁₃ are chosen so that the maximum frequency range consistent with reliable oscillation is obtained.) The values in the Components List were the optimum values used by the writer, and were found by trial and error. The values of C have been chosen to give a vibrato speed to suit the writer's preferences and the range may be changed, if desired, by selecting different values for C₄, C₅ and C₆. Care must be taken to see that these capacitors are correctly connected or they will be wrongly polarised, and difficulty may be experienced in making the oscillator function properly. The attenuation of the phase shifting network is high and so a transistor with a current gain of at least 60 is required for TR₄—the higher the better. Recommended transistors for this position are OC75 or GET102. The collector potential is set to roughly -9 volts by suitable selection of the bias resistor R₁₁. The value of this resistor depends upon the gain of the transistor and should be between 330kΩ and 1.5MΩ. If a value lower than this is required, the transistor is of low gain and unsuitable; and if a higher value is required either the transistor is of very high gain or, more likely, the leakage current of C₆ is upsetting the bias. If a meter is not available R₁₁ may be selected for most satisfactory operation of the oscillator.

In order to ensure complete reliability of the oscillator and to prevent it from being too heavily loaded it is buffered by another emitter follower TR₃. The Depth control, RV₁, is conveniently incorporated in the emitter load and is a 2.5kΩ potentiometer, preferably wirewound. If economy is required, the buffer may be omitted and the Depth control incorporated in the oscillator load as shown in Fig. 5 (note the reversal of polarity of

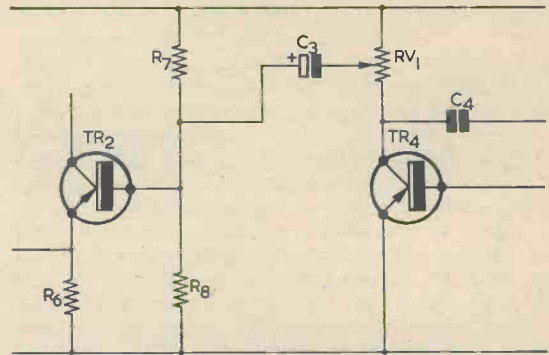

Fig. 5. The buffer transistor TR₃ could be deleted if this circuit is employed

C₃). However, the Fig. 5 circuit may cause unreliable operation of the oscillator and, for the price of one transistor and a resistor, is hardly worth-while.

The oscillator is temporarily stopped by operation of S₂, which places resistor R₁₂ across C₅ and prevents the phase shifting network from functioning effectively. This method was found to be the best as it enables the oscillator to start again quickly

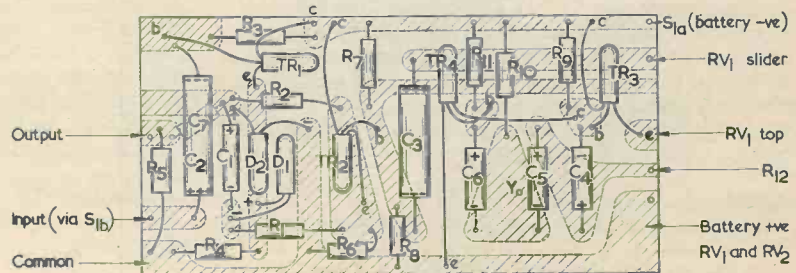
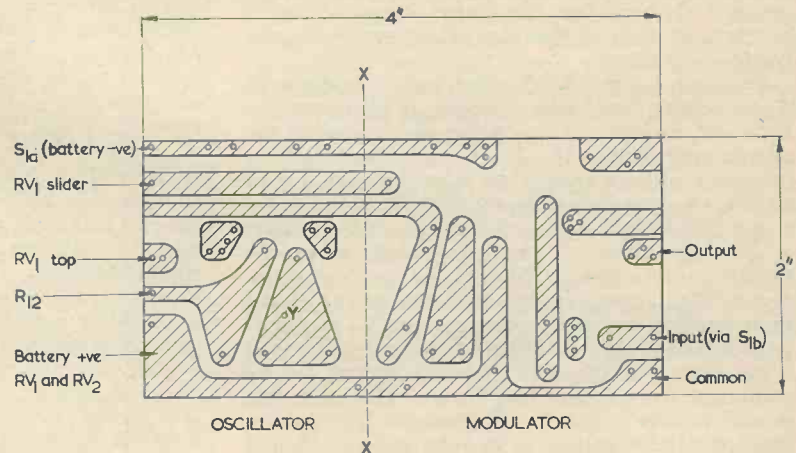

Fig. 6 (a). The copper side of the printed circuit board
(b). The components mounted on the board. In this view the copper is on the underside. C₇ is mounted below the board

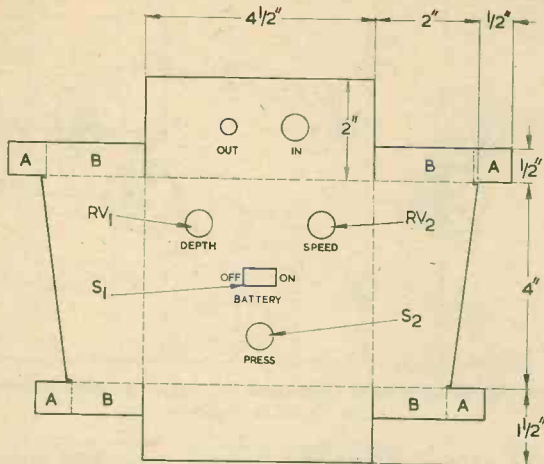

Fig. 7. Details of the case before bending. Bends should be made along the dotted lines, the size and position of holes depending on the components used. A base should be cut to fit the box ($4\frac{3}{8} \times 3\frac{7}{8}$ in approx.)

when S_2 is re-opened. Also, it produces the minimum amount of "click" on the output when the switch is operated, since it does not affect any of the d.c. levels in the circuit.

Switch S_1 is the On-Off switch and, in addition to disconnecting the battery supply, it also connects the input directly to the output via R_{14} when the unit is not switched on. This enables the battery to be saved without having to take the unit out of circuit. A large capacitor, C_8 , $250\mu\text{F}$, is connected across the battery to smooth out any ripple voltage which may appear across the supply when the oscillator is running.¹ This ripple can cause unpleasant "thumping" noises as the batteries age and their internal resistance rises but, as C_8 is rather large in size it may be dispensed with if space is at a premium, the "thumping" being filtered out by additional RC sections like $C_7 R_5$. However, this second course is not so satisfactory. The recommended battery voltage is 18 volts and this should not be exceeded or the transistors may be damaged. Although the modulator section functions satisfactorily down to quite low voltages, the oscillator may become temperamental at low voltages (although if a good transistor is used for TR_4 , operation is still satisfactory at 9 volts supply). Failure or irregularities in the oscillator are usually a good indication that the batteries need replacement. The current drain is only about 12mA and so quite a good life can be expected from them.

Additional Circuit Notes

The voltages at various parts of the circuit are

¹ In Fig. 4 and the subsequent layout diagram of Fig. 8, C_8 is shown as being connected permanently across the battery. When wired up in this manner, a small polarising current flows through this capacitor continually. A saving in battery life could be achieved by connecting C_8 into circuit after the on-off switch.—EDITOR.

Position	TABLE Voltage	Adjust
TR_1 emitter	$12V \pm 1.5V$	R_3 ; 100–270k Ω
TR_2 emitter	$6V \pm 1V$	R_7 ; 10–15k Ω
TR_4 collector and TR_3 emitter	$9V \pm 2V$	R_{11} ; 330k Ω – 1.5M Ω

Battery 18 volts
(RV_1 set to minimum and S_2 closed)

given in the table. This shows the approximate voltages which should occur with normal components and, if a voltmeter is handy, these may be checked and adjusted if necessary. The emitter voltage at TR_1 should be 5 or 6 volts less than the supply voltage and TR_2 emitter voltage should be half of TR_1 emitter voltage ± 1 volt. As mentioned earlier, TR_4 collector and TR_3 emitter should be at about half the supply voltage.

CAUTION: Do NOT connect any low resistance (milliammeter, short circuit or even high value capacitor) across any of the emitter resistors, or the initial surge of current will almost certainly destroy the transistor. This happens in a few micro-seconds and so even the shortest fault can be disastrous. This also applies to the short-circuiting of C_1 but, in this case, D_1 , D_2 or TR_1 or all three, may be damaged.

The emitter followers are inherently temperature stable and so no difficulty should be encountered if the unit is used at elevated temperatures, which may occur in cabinets or other enclosures containing valve amplifiers. The oscillator, however, is biased in a very simple manner and is very susceptible to temperature variations and so, if the unit is to be used in a position where it is likely to get warm, a high gain silicon transistor such as the OC202 could be used.²

If a deeper vibrato effect is required the modulator buffer transistor, TR_2 , may be biased so that the diode modulator section is cut off over part of the oscillator cycle. This may be achieved by setting TR_2 emitter voltage to about three-quarters of TR_1 emitter voltage (i.e. about 9V) by selecting a lower value for R_7 , suitable figures being 6.8 to 8.2k Ω .

A 15k Ω resistor should be added directly across D_1 to reduce the reverse bias when the diode cuts off, and this also helps to reduce the additional "thumping" which may be produced by unsymmetrical modulation.

Construction

The unit can be constructed in many forms and the reader will probably have his own ideas of the

² The absolute maximum V_{CE} rating ($+V_{BE} > 500\text{mV}$) for the OC202 is $-15V$. In consequence, an OC202 in this circuit will be operating at, or slightly exceeding, maximum rating when an 18V battery is employed.—EDITOR.

best method for his use. One suggested form which the writer has found very useful is to construct the unit as a box that can be used as a foot switch. The complete unit is shown on the front cover and, as can be seen from Fig. 7, it is built in a strong aluminium box measuring about 4 x 4½ x 2in, complete with Depth and Speed controls, On-Off switch and also a press switch (of the type fitted to table lamps) capable of being operated by the foot.

If the unit is to be foot-operated it must obviously be of fairly robust construction and the best way of achieving this is to mount the components on a printed board. A suitable printed board and component layout designed and constructed by the writer is shown in Fig. 6, and this holds all the components except those directly associated with potentiometers and switches. The layout has been designed in two halves so that, if the board is cut down the line XX, one half contains the modulator unit and buffers and the other half contains the oscillator with its buffers. The board was constructed using one of the printed circuits kits that are available. Standard size resistors are used throughout. Miniature capacitors are used in all positions to reduce the size, although C₂ and C₃ may be standard components, if desired. It is not proposed to describe the actual construction of the printed board but one or two points on the assembly of the components to the board are worth mentioning.

(1) Check carefully that the printed circuit is correct and that the components holes are in the correct place before mounting any parts.

(2) Mount the resistors and solder them in first of all, so that the minimum heat is applied to the rest of the more delicate components. Do not solder R₁₁ permanently into circuit until the unit has been tested.

(3) The capacitors should be mounted next, but take care that excessive heat is not applied, particularly to the miniature electrolytics, or damage may occur. Use a heat shunt if necessary. Make sure that the capacitors are connected with the correct polarity.

(4) The diodes and transistors are soldered in last of all. Cut the leads to the appropriate length for their position on the board, but no less than ¼in from the can, and fit plastic sleeving on the leads

before soldering to prevent accidental short circuits to the other components. Use a heat shunt if necessary.

(5) Check the completed board against both component layout and circuit diagram. This is most important since expensive damage could result from a wrong connection.

A suitable box for the unit is shown in Fig. 7 before bending. The shape is cut from a piece of 18 s.w.g. aluminium, and is bent along the dotted lines. The box is not very big and neat bends can be obtained by using a small vice. The lugs marked "A" in the diagram are for securing the base and, when bent under, should be about ¼in below the level of the sides. The sides then extend slightly below the base when fitted and this makes a neater job.

The writer uses a rather interesting technique in chassis construction by employing Araldite epoxy resin to fix the corners of chassis. This technique can be used here. The flanges marked "B" are coated with Araldite and then firmly clamped to the sides to form a neat corner. The whole arrangement of clamps and box is then heated to about 300°F. in an oven for about an hour, by which time the Araldite has completely hardened. Any surplus Araldite squeezed from the joint when the clamps are applied is left on and, when heated, runs into the gaps and forms very smooth corners. When the Araldite is hard it can be filed and finished like the aluminium itself and nicely rounded corners are produced. The resultant join is very strong, being much neater than joining with rivets, and it imparts a good finish to the box.

The potentiometers, which may be standard size components, should be fastened in the box before wiring, as also should the two switches. The on-off switch is a simple two-pole two-way sliding type, as fitted to many portable radios. The press switch may, of course, be replaced by a heavier duty metal type such as is used in guitar foot switches if this is thought desirable, although the normal plastic

Fig. 8. Layout of components in the case. The batteries, C₈, and the printed board when completely assembled are shown in dotted line

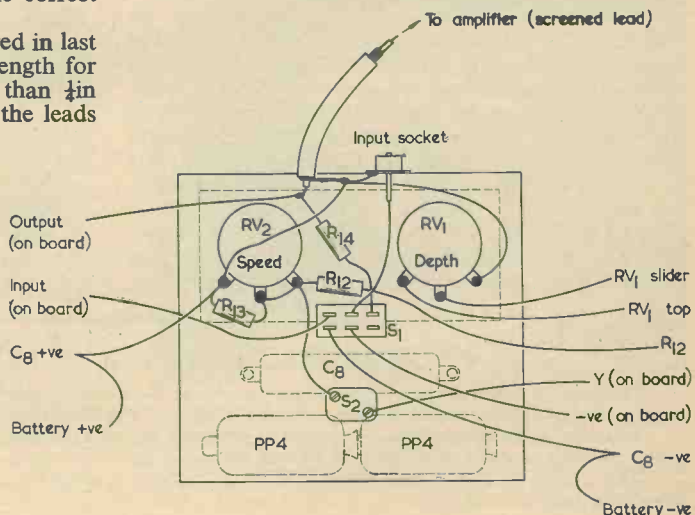

switch will stand up to quite a lot of heavy treatment. The printed board is mounted above the potentiometers on single stand-off insulating bushes which may be improvised from odds and ends in the spares box.

The components associated with the potentiometers and switches (R_{12} , R_{13} and R_{14}) are connected directly to their respective tags, and flexible plastic covered wire is used to link the controls with the printed circuit. See Fig. 8. The input socket may be of any suitable type, and a length of screened lead suitably terminated with a plug provides the output connection. Two PP4 batteries clipped end to end provide the supply, the ripple removing capacitor C_8 being connected across the battery supply leads. The arrangement of components in the box is clearly shown in Fig. 8 and the positions of the printed board, batteries and C_8 (if fitted) are indicated by dotted lines. The batteries and C_8 are held in position by the base and a piece of plastic sponge between the battery and C_8 and the switches.

This arrangement prevents any of the components moving around and hence causing trouble. Suitable plastic sponge may be obtained from any of the chain stores or occasionally with some of the detergents. A coat of crackle paint, four rubber feet secured to the base with Araldite, and a couple of control knobs finish the job off.

Testing the Unit

The unit should normally operate quite satisfactorily immediately it is switched on but in order to ensure optimum operation and reliability there are several checks that can be made.

(1) *D.C. Voltages.*—Typical d.c. voltages in various parts of the circuit with the Depth control at minimum and the oscillator stopped (by S_2) are shown in the table with the corresponding component to adjust if necessary. The meter used should be at least $1k\Omega$ per volt and great care must be taken not to short circuit any of the components when taking the measurements. R_{11} is the component most likely to require adjustment.

(2) *Oscillator Checks.*—The oscillator can be checked by observing TR_3 emitter, which will swing round from about -2 volts to -15 volts, depending on the meter damping, in sympathy with the oscillator. If the meter needle "kicks" when S_2 is operated but does not oscillate, check the phase shifting components C_4 , C_5 , C_6 and R_{10} , R_{12} , R_{13} and RV_2 , paying particular attention to the polarity of the capacitors. Adjust the values of R_{12} and/or R_{13} so that the oscillator operates over the whole range of RV_2 . If the oscillator still does not function despite these checks, the gain of TR_4 may be low,

although this should be apparent from the value of R_{11} , as mentioned previously.

(3) *Modulator Checks.*—If the oscillator appears to function correctly but the input is not being modulated check that, with the Depth control set to maximum, TR_2 emitter voltage swings by about the same amount as TR_3 emitter. If it does, but the input is still not being modulated, then there is a fault in the diode modulator circuit. Check that the diodes are connected with correct polarity and that C_1 is correctly connected. The voltage across the diodes should not exceed 0.5 volt when correctly connected, but if they are wrongly connected almost the full oscillator voltage will appear across them.

Conclusion

The vibrato unit has been in use for some time, by the writer and some guitar playing friends, during which time it has proved very convenient and very reliable. The battery drain is fairly small and the batteries should last several months depending upon the amount of use. A small mains unit using a 12 volt heater transformer and 4 diodes in a bridge rectifier circuit could be used instead of the batteries if desired, although the writer's unit was initially built to be self-contained. The unit is fairly small as it is, but by using a slightly simplified circuit and miniature components it could be made small enough to actually fit inside the guitar itself. The writer is at present working on a design using $\frac{1}{10}$ watt resistors, micro-alloy transistors, and sub-miniature capacitors, potentiometers and diodes. The unit will be encapsulated in Araldite and be powered by miniature mercury cells, so that it can be fitted in the control panel in the guitar.

The modulator section of the vibrato unit has many applications in the control of audio frequency signals. By deriving the modulating voltage from a suitable trigger circuit operated by the input signal, the rise and decay times of the output from the modulator can be controlled. This effect is often used with electronic instruments and is particularly useful with electronic organs to remove the keying effects. By operating the modulator from a d.c. modulating voltage proportional to the average amplitude of the input signal the modulator section will behave as an automatic volume control. This is very useful in controlling tape recording levels when the sound source is moving around relative to the microphone.

The modulator section of the vibrato unit is obviously a very useful device, but readers interested in other applications are recommended to re-read the section on its principle of operation before setting out to design any other unit.

MALAYSIA PLACES ANOTHER TV CONTRACT WITH EMI

Ministry of Information and Broadcasting, Malaysia, has now awarded EMI Electronics Ltd. a further contract to supply equipment for the First Phase of the Malaysian Television Service.

Included in the contract are two image orthicon cameras and associated equipment, picture monitors, vision and sound mixing consoles, for use in a second studio at Kuala Lumpur.

This order follows within three months the previous contract awarded to EMI to provide equipment for the Malaysian Television Service.

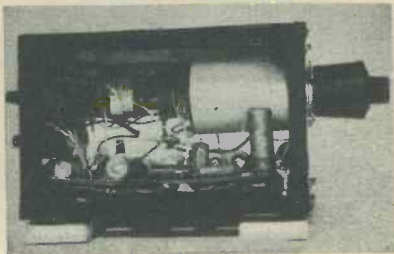

TRANSISTORISED HOME BUILT CLOSED CIRCUIT TV

Part 4—R. Murray-Shelley
and T. Ian Mitchell

The last in a series of four articles describing the construction and operation of an amateur-built closed circuit television camera. The camera, which is fully transistorised, provides an r.f. output at any channel in Band I and it may, in consequence be used in conjunction with a conventional domestic television receiver

IN THIS CONCLUDING ARTICLE OF THE SERIES WE shall give details of the setting up procedure for the camera together with some notes on its use.

Setting Up Procedure

The first and most essential part of this operation is to thoroughly check all the wiring. Special attention should be paid to the transistor connections. The connections to the Vidicon should also be checked.

It is suggested that the first tests be made with the Vidicon out of the camera.

Connect the camera output to the input of the television receiver which is to be used as a monitor via a length of coaxial cable. The receiver should be tuned to a channel in Band I. (Band I covers Channels 1-5 inclusive.) The channel selected should be other than that on which the local B.B.C. transmission is radiated.

Next connect in the 12 volt supply and tune the camera r.f. oscillator to the receiver frequency. The screen of the receiver will brighten considerably when this is done—tune for maximum brightness of the screen. C_{13} should, of course, be adjusted using an insulated trimming tool. Should the unit not oscillate, reverse the connections to L_2 . The trimmer C_{12} should be set to a low capacitance for this part of the operation.

The video amplifier can be empirically checked at this stage by applying some sort of signal to the input. Just touching it with the finger should result in an intense pattern forming on the monitor screen.

The line frequency can now be adjusted by varying the inductance of L_4 . Correct adjustment is characterised by the receiver horizontal hold control being at about the centre of its travel when the picture is stable in a horizontal direction.¹ The line frequency

was found to be a little critical with some receivers, notably those using electrostatic focusing.² Notice that at this stage no vertical sync is being applied to the receiver.

The Vidicon tube can now be fitted into the camera and the lens system fixed in place. Be careful not to damage the side pip on the Vidicon—careless handling could easily break it off and ruin the tube. The rest of the camera power supplies are now connected in. Make sure before doing this that the target and beam controls are set to minimum.

Allow the Vidicon to warm up for at least one minute. Fix the camera on a suitable scene—an outside view with plenty of light is best—and set the target to a low voltage (about 20 volts). Now slowly increase the beam until a picture is obtained.



Another picture reproduced by way of the camera and a domestic television receiver

¹ Or when the control takes up a central position within the limits needed for reception of B.B.C. signals.—EDITOR.

² The main difficulty given with electrostatic focus receivers was found to be impairment of focus at incorrect line frequencies.

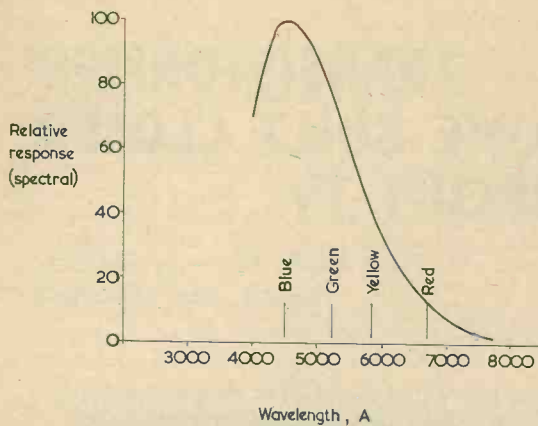

Fig. 19. The spectral response curve for the Vidicon "Amateur" grade 10667M (E.M.I. Electronics Ltd.)

Adjust the coarse (electromagnetic) focus control initially for best focus. Later adjustments can be made with the fine (electrostatic) focus control.

The optical focus control must naturally be correctly set if a well focused picture is to be obtained. The use of three focus controls, two electronic and one optical, takes a little getting used to. In practice the coarse focus control is rarely used and experience tells whether the optical or electrical focus is in need of adjustment.

Having obtained a picture—of sorts—slide L_3 towards L_1 (see Fig. 10 in Part 2 of this series) until a point is reached where there is no crushing of the white parts of the picture and the line and vertical hold on the monitor are solid. As was mentioned earlier, too much coupling may result in vertical juddering. Once L_3 has been correctly adjusted, it can be held in position with polystyrene cement.

The trimmer C_{12} should be adjusted in conjunction with L_3 , until optimum conditions of field and line stability are reached. The exact adjustment of this trimmer will depend to some extent on the type of monitor used. Notice that increasing C_{12} too much will prevent the oscillator operating.

The value of C_7 may need adjustment depending on the monitor used.

The width and height controls should be adjusted until the edges of the target just disappear. The vertical linearity control should be adjusted until there is no change in the height of an object as it is moved from one part of the field of view to another. The aspect ratio of the picture should be the standard 4:3. The correct relation between height and width can be obtained by focusing the camera on a circular object—it should appear circular in the monitor.

It may be found instructive to check the waveforms present in the circuit with an oscilloscope if this is available. Care should be taken not to operate, or attempt to operate the camera in the event of failure of the line and/or vertical timebases. The lack of drive could result in serious damage to the Vidicon.

Light

The Vidicon is very sensitive—far more sensitive than, for example, ordinary photographic film. One disadvantage which is inherent in the Vidicon, however, is that if the incident illumination is low, the tube takes rather a long time—relatively—to respond to changes in illumination. The result of this is that when the light level is low a sharp well focused picture can be obtained, but smearing on moving objects will be observed. The contrast obtained in a picture of a dimly lit scene will also suffer. Further, if the light input to the tube is low, it will be necessary to raise the target voltage rather a lot in order to resolve a picture. This will cause any blemishes on the target to show up.

The lesson to be learnt from these remarks is that the scene to be televised should be well illuminated. Front lighting is best and for indoor scenes can be provided by one or two 150 watt lamps in reflectors. As can be seen from the relative spectral response curve shown in Fig. 19, the standard 10667 Vidicon is rather more sensitive to light in the blue region than in any other.

Too high a target voltage will result in the picture going partially or completely negative. The beam control on the CCTV camera is in some ways analogous to the brightness control on a normal receiver. The target voltage control has a similar effect to the contrast. These two controls are, however, interdependent, and in general the beam control should be set so as to just discharge the highlights in the picture.

Beam Alignment

No provision has been made in this circuit for any electrical alignment of the electron beam in the camera tube. The guns of Vidicon tubes are normally very accurately aligned and, provided the tube is located accurately in the focus coil, no further alignment is normally required. The test for accurate alignment is to defocus the picture with the fine focus control. If the alignment is good the picture should rotate out of focus with little lateral shift.

Camera Mounting

The method which is adopted for mounting the

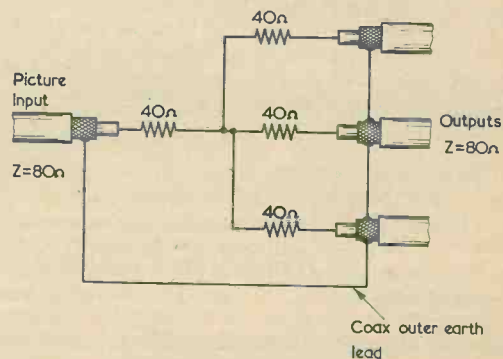

Fig. 20. A 3-way outlet box for splitting the modulated r.f. signal

camera will depend rather on what the individual constructor has at his disposal. The camera is not particularly heavy and therefore quite a small tripod could be used. A ball and socket head of the type used for film cameras might be pressed into service.

More than one monitor could be used with the camera. Some sort of distribution network is then required—a suitable circuit is shown in Fig. 20, which allows 3 monitors to operate. Up to 6 receivers can be run from the camera by an extension of this method. It might be advisable in this case to raise C_8 considerably—say to between 330pF and 1,000pF. If this is done, some adjustment of the coupling winding L_3 may prove to be necessary.

Television Production

It is not the claim of the writers that they are well versed in the field of television production. Quite ambitious programmes can be produced with the type of equipment described here, provided that its limitations are realised. The primary drawback is that usually only one camera is available, and it will have only one lens. There is perhaps what might be described as a “fundamental principle” for this type of production—that is, to keep the camera still and let the subjects move. Very rapid camera movements can only be achieved after much practice, since they invariably call for refocusing and adjustment of the tube controls. In any case, panning of the camera should always be done slowly as it will be found that this gives a better overall effect.

If some sort of commentary is required as is usually the case, it is normally simpler in the long run to use a separate p.a. system rather than to try to incorporate a sound channel with the video signal from the camera.

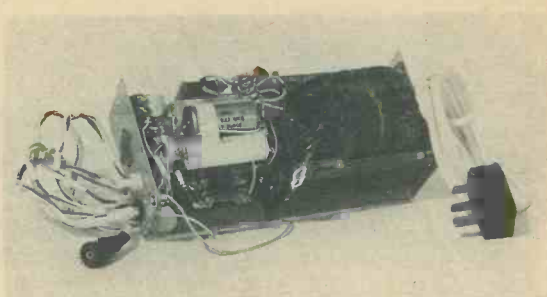

The power supply unit employed by the writers

Talkback facilities should be provided between the camera operator and the producer. Background music can be provided usually by some combination of tape recorder and record player.

For setting up and introductory purposes, some form of test card is required. The exact design of this card is left to the imagination of the individual, but it should contain test bars and circles as well as a graduated tone scale. A photograph can also be incorporated as a very useful focusing aid. The test card can be made using indian ink on a white background.

There is no limit to the complexity and the facilities which can be introduced into a closed circuit television system. The cost is one limiting factor which has for a long time plagued work in this field. We have tried to show in these articles that it is possible to produce equipment capable of giving very good results for a reasonable outlay. More complicated systems might well be built up by groups of amateurs and clubs as a joint project.

AEI to design and build £250,000 Radio Telescope

A new 82ft steerable aerial, to be used by DSIR for studying radiation and radio signals pick-up, is to be built at Chilbolton, Hampshire. The Ministry of Public Building and Works has placed a £250,000 contract for the detailed design and installation of the aerial with AEI's Electronics Group.

The moving structure will weigh approximately 300 tons and be controlled in winds of up to 45 m.p.h. to a pointing accuracy of two minutes of arc.

The dish and backing structure, control system and mounting have been designed by the Electronic Apparatus Division of AEI's Electronics Group, which also specified the design parameters of the supporting towers.

The aerial will be mounted on altazimuth axes but will be controllable in equatorial co-ordinates for astronomical work.

Drive motors will be supplied by AEI's Motor and Control Gear Division.

The AEI Electronics Group already has a wide experience in this type of work including provision of the control system for the 210ft diameter radio telescope at Parkes, Australia—the most accurate steerable radio telescope in the world.

USE OF TOOL-CLIPS IN CONSTRUCTIONAL RADIO WORK

by E. Lawrence

DESPITE THE VERY WIDE RANGE OF RADIO components which have been designed to fulfil specific functions, the experimenter often solves a constructional problem by pressing into service something originally intended for a non-radio purpose. Many of the items developed as a result of the "do-it-yourself" vogue fall into this category. The spring tool-clip is a long-established adjunct of the workshop and forms a very good example of the type of article which can be put to many uses other than that for which it was designed, and it is readily available from most tool and general ironmongery suppliers in a range of sizes from about $\frac{3}{8}$ to 3in, with plated or coloured plastic finish.

Wiring

Maintaining a neat layout as lengthy power supply leads accumulate is a frustrating aspect of constructional radio. A neat below-chassis appearance quickly degenerates into an untidy mess as work progresses, and any method which renders a bunch of wires less intractable is worthy of trial. The first illustration shows a complex wiring scheme built up progressively from various diameter single insulated conductors, and then finally tidied up with short lengths of wide gauge plastic tube and secured to a flat surface with tool clips. A feature of this technique is that the spring action of the clips not only exerts a firm safe hold but, at the same time, allows the removal of the article held any number of times without the use of tools or fear of damage. The smallest size clips are ideal for a single thick conductor and serve admirably when installing television coaxial cable. Should a wire be expected to carry voltage in excess of the rating of its insulation a large diameter plastic tube can be added to afford extra electrical and mechanical protection.

Mounting Relays

When drilling the requisite holes for relays in an aluminium chassis with a hand tool, it is often difficult to ensure correct alignment. If a number of relays are to be fitted, not only is the task a tedious one but the result is often unsatisfactory due to the untidy appearance of those which are not quite square with the others. Much of this tedium can be avoided by employing a pair of tool-clips to grip the

relay coil. Only two holes per relay are now needed and the problem of correct alignment is greatly simplified. Also, with the introduction of a suitable plug and socket into the associated wiring, the relay can be removed for spring adjustment and contact cleaning, or be changed to one of different coil resistance, with little difficulty. A typical Post Office type 3000 relay is shown with its associated clips in the second photograph.

Transistors and Other Components

The miniaturisation of components as a result of the development of transistors has removed the need to secure them in the manner common to their larger counterparts. However, where, for the sake

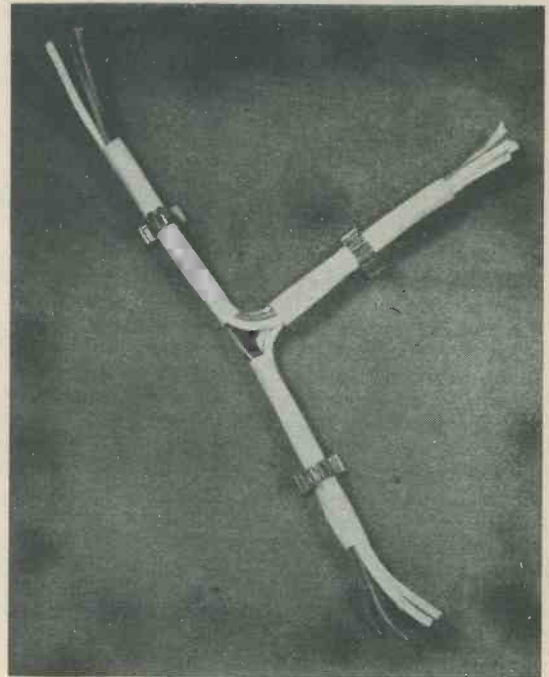

A complex wiring layout presents a very tidy appearance with the aid of tool-clips

of appearance, it is desired to anchor transistors to a surface, they may be gripped in a clip of appropriate size. This will also afford a degree of coupling to the chassis mass and may contribute favourably to the transfer of heat from the transistor, but care is necessary in the application of this feature and manufacturers' recommendations should not be disregarded.

Any component of cylindrical form, such as an electrolytic capacitor, can be fixed directly to a chassis by means of a tool-clip. Where a difference of potential exists between the outer case of the component and the surface to which it is to be attached, either a plastic covered clip should be used or it will be necessary to interpose a layer of insulating material. The type of insulation employed must take into account the question of heat dissipation, if applicable.

It is not unusual nowadays to encounter valves which have flying leads in place of the conventional plug-in base and the attendant mounting problems can be overcome, with little risk of damage to the relatively fragile glass envelope, by selecting a suitable size tool-clip. Examples of such a mounting, together with that for a transistor, can be seen adjacent to the relay in the second illustration.

Valve Top-Cap Connectors

Tool-clips can be used to advantage in lieu of the conventional pattern of valve top-cap connectors. It is not an uncommon experience, when removing an ordinary type of connector which has been in

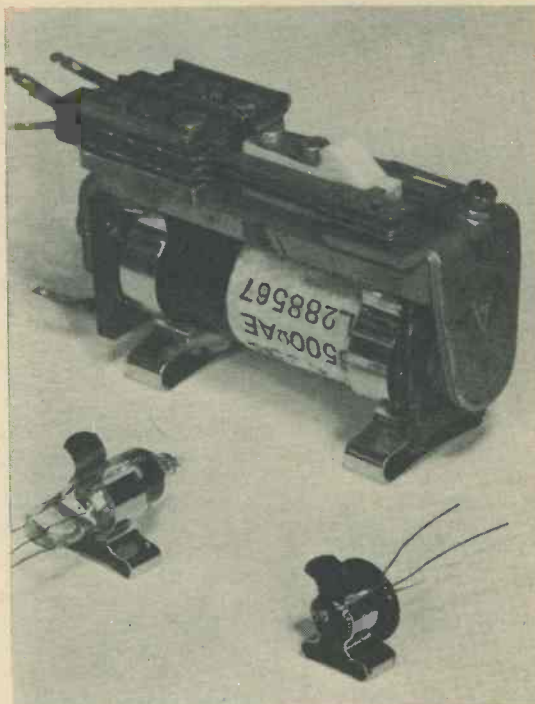

The clips are especially useful for mounting relays, small wire-ended valves, transistors, and other components with cylindrical bodies



A neat solution to the problem of the top-cap connector

position for a long time, to find that it is so firmly attached to the top-cap that any attempt to remove it by force results in the cap parting company with the valve. This problem is especially acute when the valve is inaccessibly placed, whereupon the task of removing the connector and then replacing it may require considerable dismantling of the equipment. Such difficulties are largely eliminated by the spring action of the tool-clip. In the third illustration a grid-stopper resistor has been attached by means of a short tagstrip.

General Applications

Radio is an expensive business and it is satisfying to find a component of high quality and versatility at a price which enables even the most impecunious experimenter to keep a selection close to hand for the many small mounting problems which arise in the course of his work. The writer has used these clips for many purposes; as door clips, instrument cabinet lid catches, for supporting mechanical loads, for temporary electrical connections in the same manner as crocodile clips. Plug-in units as used for receiver band-changing coil packs, require positive electrical connectors which can be easily disconnected by a light pulling action. Such connections can be established with the aid of these clips in association with suitable contact bars.

The clips are also very useful, of course, for holding tools!

An Interchangeable

Oscilloscope

PART 3

by J. Hillman

Testing the Timebase and X Amplifier

HAVING CHECKED OVER THE WIRING CAREFULLY, the timebase and X amplifier unit can now be coupled up to the power supply by means of the octal plug. Switch on and see if the valves light up then check that there is h.t. voltage at pins 7, 8 and 9 of V_1 , pins 1 and 6 of V_2 and pin 6 of V_3 . Next couple up the sockets on the back of the chassis to the sockets on the c.r.t. unit, "Grid" connecting to "Grid", "Int. Sync" to "Int. Sync", and "X" to "X". The connections should be made with short pieces of unshielded flex having wander plugs at both ends. With the Beam switch of the c.r.t. unit at the on position, a straight line should appear on the screen, and this line should be capable of being varied in length by operating VR_{10} . (Fig. 28).¹ The maximum expansion of the line

¹ Circuit references to components in the timebase and X amplifier unit apply to Fig. 28, which was published in last month's issue.

should occur when S_4 is in Position 1, i.e. Non-Linear. The setting of the linearity controls can be left until the Y amplifier is coupled up, although if it is desired to set those up the following procedure may be adopted. Connect a mains a.c. voltage in series with a $0.1\mu F$ capacitor to the Y socket of the c.r.t. unit, a convenient source of a.c. being the heater voltage. With the coarse frequency switch S_3 in Position 1, and the sync switch S_2 in the "Int Sync" position, advance the sync gain control VR_6 slightly and adjust the fine frequency control VR_8 until a stationary trace of about 4 c/s appears on the screen. If the trace does not remain stationary VR_6 may need to be further advanced. Having got a satisfactory trace, put the linearity switch S_4 to Position 2 (Linear) and adjust the X amplitude control VR_{10} so that the trace is spread across the screen. The trace will probably be cramped at one end or in the middle, so next adjust VR_7 and VR_9

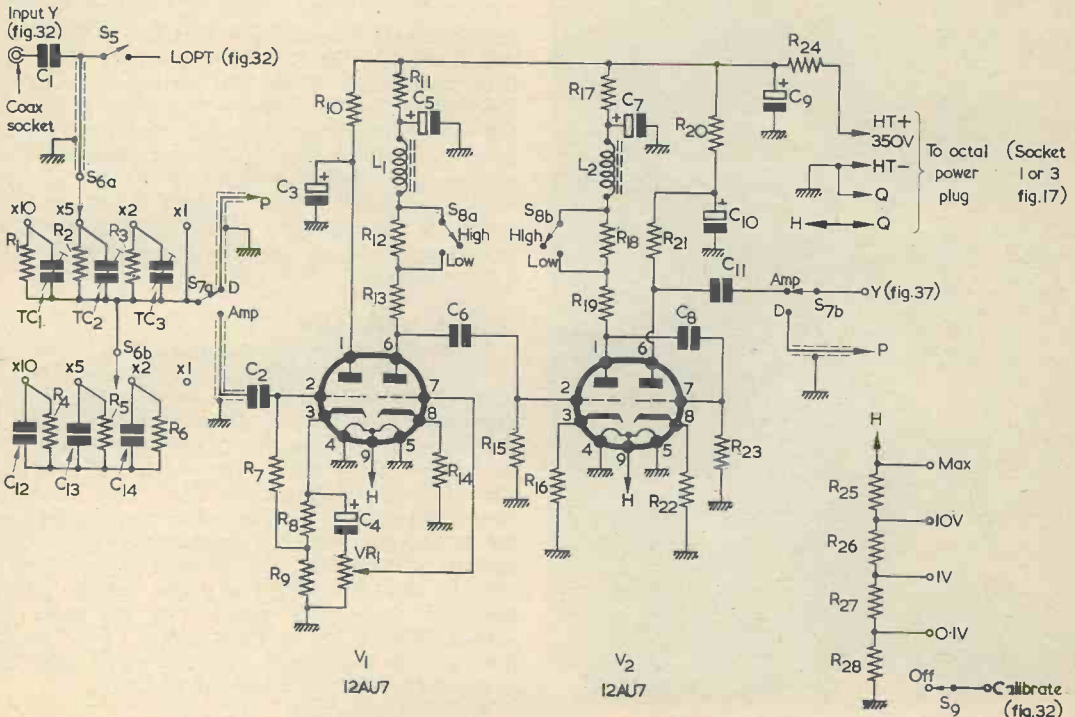

Fig. 31. The circuit of the Y amplifier unit

Components List

(Fig. 31)

Resistors ($\frac{1}{2}$ watt 10% unless otherwise stated)

R ₁ 1M Ω	R ₁₅ 1M Ω
R ₂ 1M Ω	R ₁₆ 470 Ω
R ₃ 1M Ω	R ₁₇ 10k Ω
R ₄ 100k Ω	R ₁₈ 22k Ω
R ₅ 220k Ω	R ₁₉ 4.7k Ω
R ₆ 470k Ω	R ₂₀ 10k Ω
R ₇ 1M Ω	R ₂₁ 22k Ω
R ₈ 220 Ω	R ₂₂ 470 Ω
R ₉ 4.7k Ω	R ₂₃ 1M Ω
R ₁₀ 56k Ω	R ₂₄ 2.7k Ω 1 watt
R ₁₁ 10k Ω	R ₂₅ 39 Ω 5%
R ₁₂ 22k Ω	R ₂₆ 470 Ω 5%
R ₁₃ 4.7k Ω	R ₂₇ 47 Ω 5%
R ₁₄ 470 Ω	R ₂₈ 5 Ω 5%

Potentiometer

VR₁ 5k Ω carbon (Y amp)

Capacitors (all 350V wkg unless otherwise stated)

C ₁ 0.5 μ F
C ₂ 0.25 μ F
C ₃ 8 μ F electrolytic
C ₄ 100 μ F electrolytic, 25V wkg
C ₅ 2 μ F electrolytic
C ₆ 0.25 μ F
C ₇ 2 μ F electrolytic
C ₈ 0.25 μ F
C ₉ 16 μ F electrolytic
C ₁₀ 8 μ F electrolytic
C ₁₁ 0.25 μ F
C ₁₂ 50pF
C ₁₃ 25pF
C ₁₄ 10pF
TC ₁ 3-15pF trimmer
TC ₂ 3-15pF trimmer
TC ₃ 3-15pF trimmer

Valves

V₁, V₂ 12AU7

Switches

S ₅ 1-pole, 1-way (L.O.P.T.)
S ₆ 2-pole, 4-way (attenuator)
S ₇ 2-pole, 2-way (direct amplifier)
S ₈ 2-pole, 2-way (amplifier gain)
S ₉ 1-pole, 5-way (calibrate)

Inductors

L₁, L₂ Long wave coils, dust cored

Miscellaneous

- 2 B9G valveholders
- 1 18-way miniature tagstrip
- 4 Pointer knobs
- 3 Wander plug sockets
- 1 Coaxial socket
- 1 Octal plug
- 1yd 4-core flex

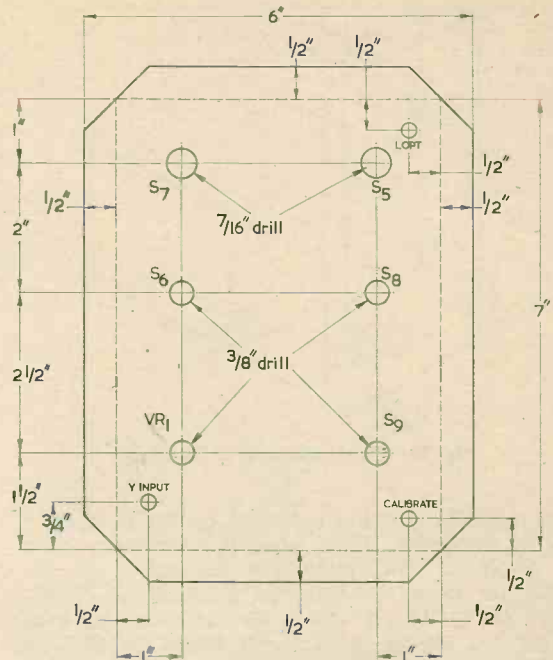

Fig. 32. The Y amplifier front panel

to give the most linear trace, this being indicated by the fact that each cycle is the same shape.² By adjusting the frequency control a number of different traces will be obtained and the frequency setting of

² If difficulty is experienced in obtaining a linear trace, it may be helpful to experimentally adjust the value of R₁₁.—EDITOR.

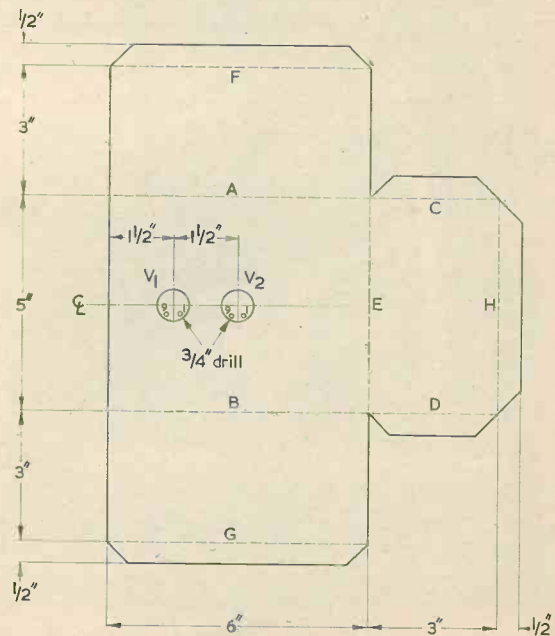

Fig. 33. The Y amplifier chassis

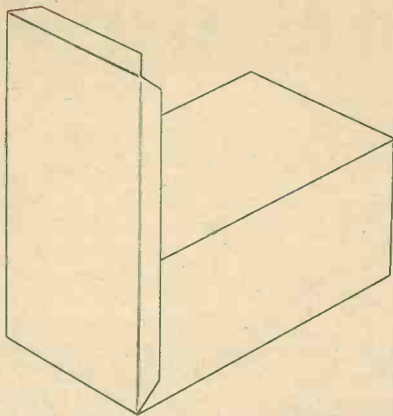

Fig. 34. Fitting the panel to the chassis

the timebase is easily indicated by the number of cycles displayed. Thus, when one stationary cycle is displayed, the timebase is running at 50 c/s; with two cycles the timebase frequency is 25 c/s; with four cycles it is 12.5 c/s; and so on. By applying other a.c. sources such as the audio output of a signal generator, other speeds can be calibrated if desired. If the frequency of the signal generator audio output is not known it may be determined first setting the timebase to 50 c/s and then applying the audio signal from the generator to the Y socket of the c.r.t. unit and counting the number of the complete cycles shown on the trace. By multiplying this number by 50 the approximate frequency of the audio signal can be found. Thus, if the number

of cycles is six, the audio frequency is approximately 300 c/s.

The ranges of the coarse frequency switch are as follows: Range 1, 5 to 150 c/s; Range 2, 50 to 2,500 c/s; Range 3, 2 to 50 kc/s; Range 4, 6 to 350 kc/s; Range 5, 140 to 600 kc/s; Range 6 is the off position.

The beam blanking control, VR₅, is adjusted as follows, with a trace on the screen turn up the brightness until the flyback line joining the two ends of the trace is visible. Then adjust VR₅ so that this line disappears, leaving the forward trace only.

Construction of the Y Amplifier

First mark out and drill the front panel, as in Fig. 32, then bend the $\frac{1}{4}$ in edges at right angles as shown. Next mark out the chassis (Fig. 33) and bend the edges in the following order: A, B, C, D, E, F, G and H. Bolt up edges C and D with 6BA nuts and bolts, fit the front panel to the chassis as in Fig. 34, and secure with 6BA nuts and bolts. Valveholders V₁ and V₂ are fitted next, with pins 1 and 9 having the orientation as shown in Fig. 33. Fit components to the front panels as in Fig. 32. Fix a miniature 18-way double-bank tagstrip on insulated bushes about $\frac{1}{2}$ in off the chassis surface and with about $\frac{1}{4}$ in clearance from the adjacent chassis sides, see Fig. 35. Drill the back panel as shown in Fig. 37 and fit the grommet and wander plug socket. Finally make the baseplate and top cover, as shown in Figs. 38 and 39.

Wire up to the circuit diagram of Fig. 31 and the layout diagrams of Figs. 35 and 36. Coaxial leads are used for the three screened wires shown in the circuit diagram, and these come up through the chassis by way of the three large grommets shown

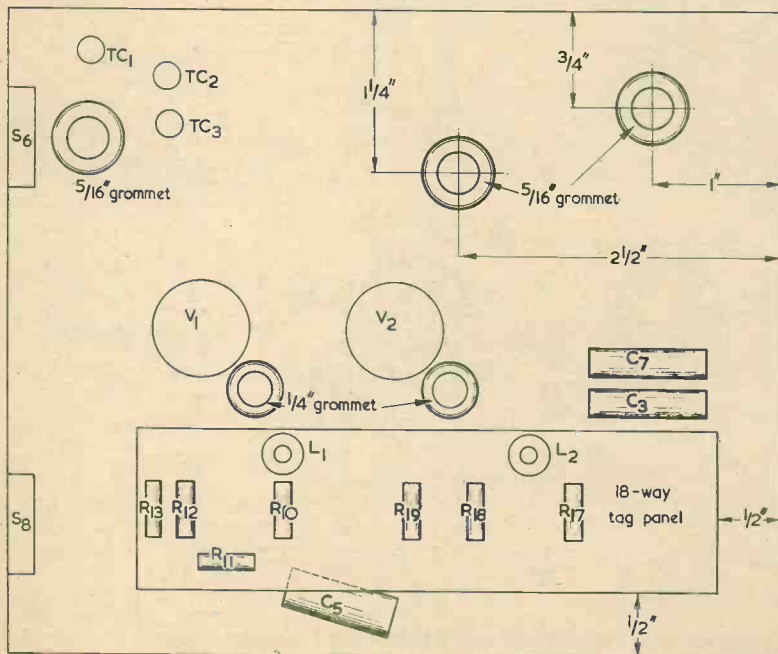
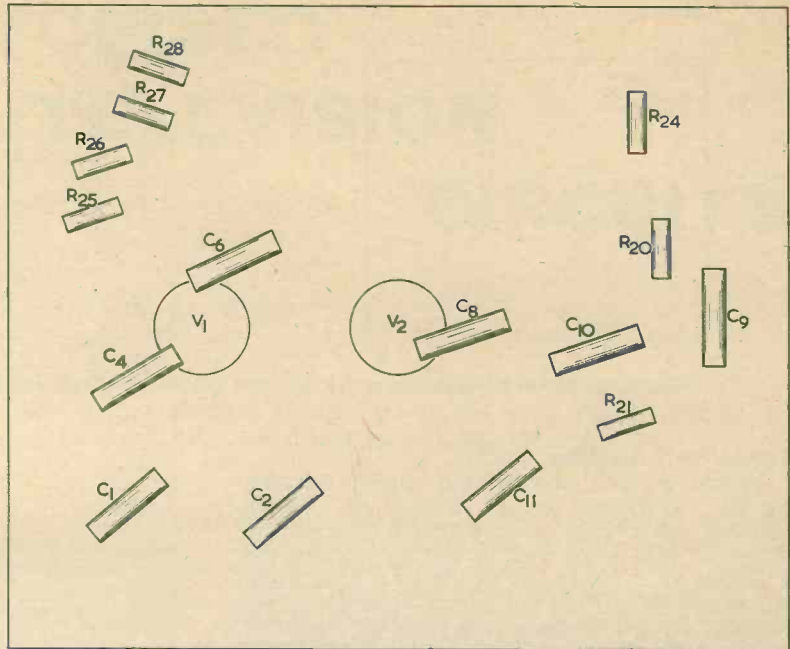

Fig. 35. The above-chassis layout

Fig. 36. The layout below the chassis



in Fig. 35. A screening can is used for V₁. Approximately 1 yard of 4-core cable is used for power supply connection, the lead terminating at one end in an octal plug wired to fit Socket 1 or 3 of

earthed at the Y amplifier chassis corresponds to that similarly earthed at the X amplifier chassis. All wiring must be as short as possible.

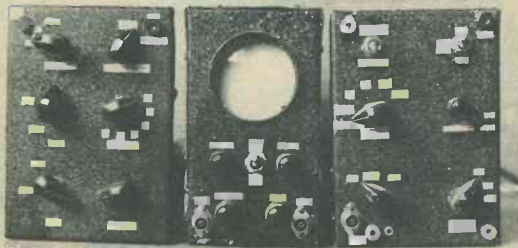

Front panels of the units

Fig. 17 (published last month) and the other in a 5-way tagstrip bolted to the side of the chassis. It is very important to ensure that the heater lead

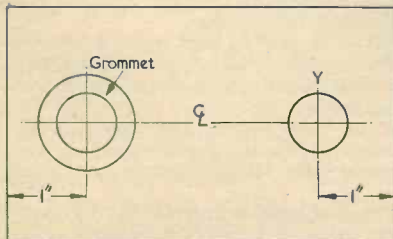
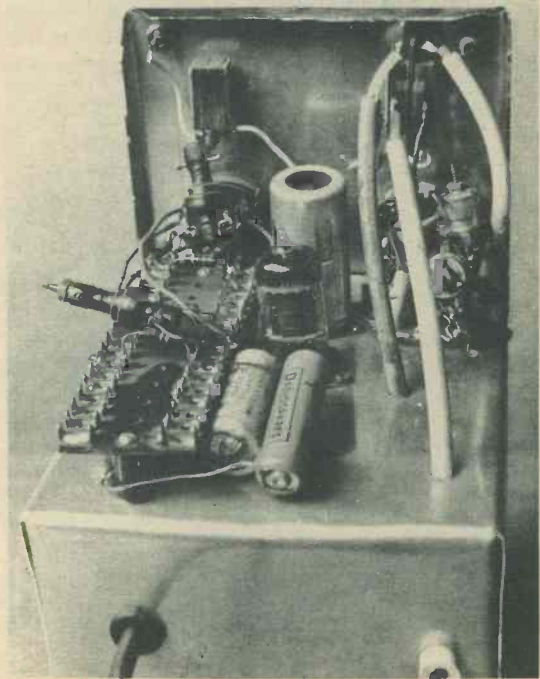

Fig. 37. The rear of the Y amplifier chassis



Above-chassis view of the Y amplifier

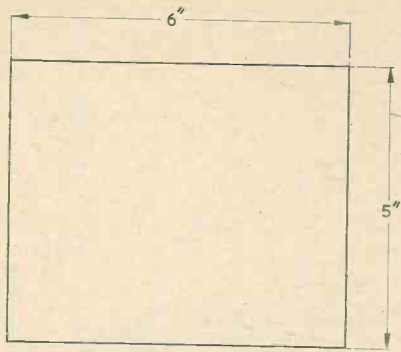

Fig. 38. The baseplate

Testing the Y Amplifier

Having checked over all the wiring, the unit can now be coupled up and switched on. Ensure that the valves light up and that h.t. voltage is present at pins 1 and 6 of V_1 and V_2 . Couple the Y socket to the Y socket of the c.r.t. unit, using unscreened flex. First put switch S_7 to the direct position, D, and couple a lead from the Calibrate socket to the Y Input socket on the front panel. Set the attenuator switch, S_6 , to the X1 position. A sine wave trace should now appear and this should vary in height when S_9 is switched to different positions. Now switch S_7 to the A (amplifier) position, set S_8 to the Low position and ensure that the Y amplitude control, VR_1 , increases the height of the trace as it is turned. Leave this control at a high setting, and check that the attenuator switch S_6 decreases the height of the trace as it is switched from X1 to X2 and through to the X10 position. Now check that there is a large increase in height of trace when amplifier switch S_8 is

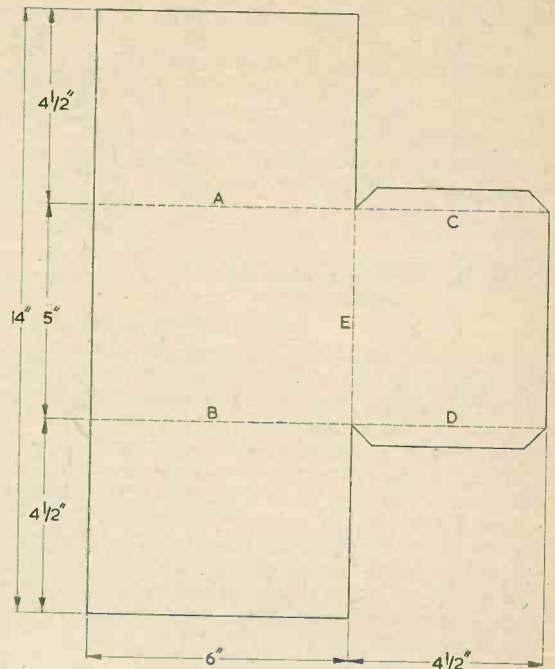

Fig. 39. The top cover

placed in the High position, To adjust trimmers $TC_{1,2}$ and TC_3 a square wave input is required, the trimmer being adjusted to give a similar waveform to that obtained in the X1 position. The calibration switch is used to decide the height of any trace and is marked in peak-to-peak voltages.

(Conclusion)

Switzerland's New Mountain Top "Car Calling Network"

Ten VHF radio-telephone transmitters which will form a new permanent network for the public car-calling service in Switzerland have been ordered from Standard Telephones and Cables Limited, London.

Placed at strategic high points above the valleys, these transmitters will be used by telephone operators for calling subscribers—private motorists or commercial vehicles—to tell them that a message awaits them. On receipt of such a call on his radio receiver the driver stops at the nearest telephone box and dials the operator or the person who wishes to contact him. The call is thus completed over the normal telephone system.

In this way a low-cost service can be provided for subscribers "on the road" without the expense of fitting radio transmitters in subscribers' vehicles. Main reason for the service, however, is that normal low-powered mobile radio transmitters are swamped by the mountains which make two-way mobile radio telephone service very difficult and unreliable.

The car calling service, at present in limited operation on an experimental basis, is provided by the Swiss Post and Telegraph administration.

The transmitters to be supplied are STC type DU-6A, with an output of one kilowatt in the frequency range 100 to 156 Mc/s.

TRANSISTORISED TELEVISION CIRCUITS

PART 6 By Gordon J. King,
Assoc.Brit.I.R.E., M.T.S., M.I.P.R.E.

In this, the last in the series covering the circuits employed in transistorised television receivers, our contributor describes a new vertical timebase circuit, then carries on to discuss power supplies. The series then concludes with information on servicing these receivers

New Vertical Timebase Circuit

BEFORE WE GO ON TO CONSIDER TRANSISTORISED television power supplies a new and interesting vertical timebase using no inductors or transformers is worth looking into, and will tie up with what was said last month.

The circuit has recently been developed by the Radio Corporation of America and is the subject of a patent. It is not possible at the time of writing to show circuits, but the arrangement is basically as follows.

The vertical scanning coils are directly coupled to a pair of complementary transistors in Class B push-pull.¹ A "discharge transistor", along with a "charging capacitor" (see Part 5) produces the drive signal and is responsive to the vertical sync pulses. The capacitor charge is reversed in one direction by the discharge transistor and in the other direction by the output circuit.

Two feedback paths are used, one to supply a forward bias to the discharge capacitor from one transistor of the output pair, which conducts during the latter portion of the sawtooth current waveform in the scanning coils, and the second to provide a pulse for the discharge transistor when the transistor of the output pair (as above) "bottoms" near the finish of the sawtooth cycle.

A driver transistor is used between the discharge transistor and the output stage and positive feedback is applied to the driver. A constant current charging source is given by virtue of the path from the output stage to the charging capacitor, and the same path constitutes a negative feedback loop which linearises the sawtooth current waveform.

The circuit has good noise performance, being immune to noise pulses between the sync pulses, and has excellent thermal stability.

Power Supply Arrangements

Turning now from the vertical timebase to the power supply circuits, we find that the majority of

¹ See "Complementary Circuits using PNP and NPN Transistors", by Mullard Limited, leaflet No. TP517.

transistorised television sets are designed to work from (a) internal battery or cell, (b) external battery, and (c) mains power supply. Mains-derived power may be either from the "trickle-charging" of the internal battery or from a specially designed regulated power supply unit.

The Pye TT1 set, for example, works either from its own internal battery, which is a 10-volt, nickel-cadmium accumulator, from an external 12-volt car battery, or from an a.c. mains supply of 200-250 volts, 50 c/s.

The basic power supply, however, is the nickel-cadmium accumulator. This type of battery differs from the ordinary lead-acid accumulator in that it



Transistorised portable television with three-band radio by Global Electronics

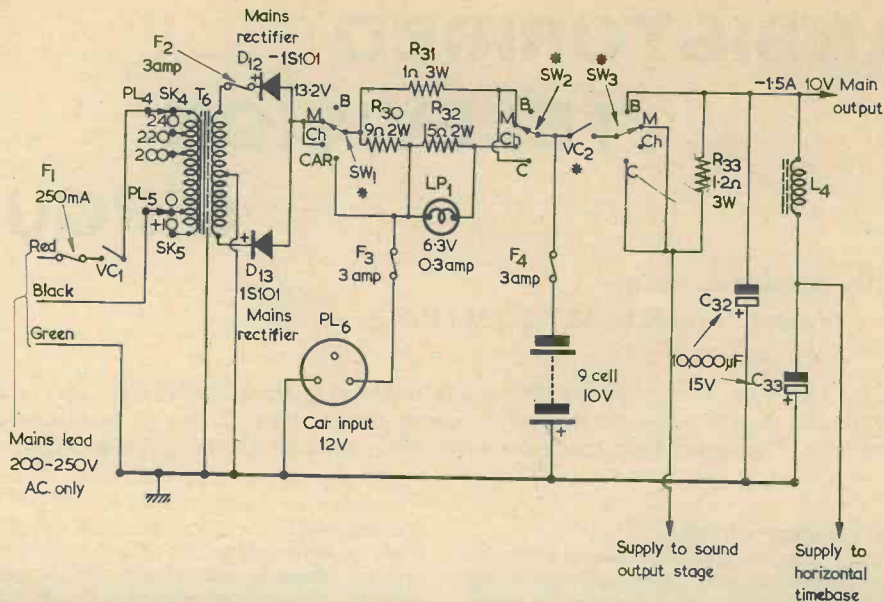
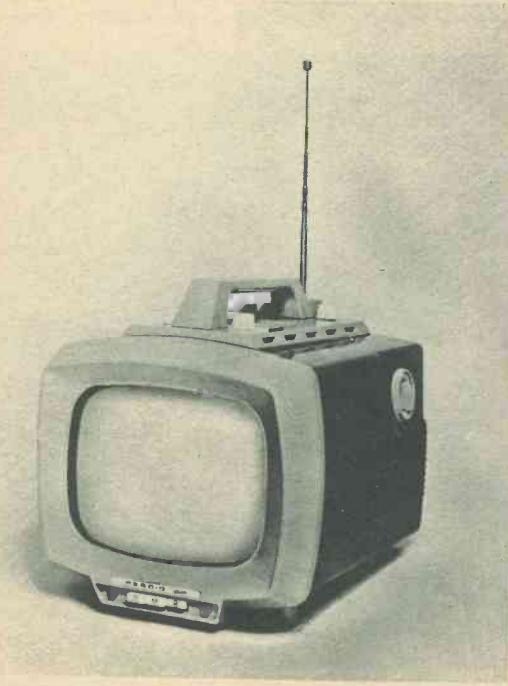

Fig. 19. Power supply arrangements of the Pye TT1. The switches marked with an asterisk are ganged, e.g. SW₁, SW₂ and SW₃ and VC₁ and VC₂. The former is the function switch and the latter the on/off switch, ganged to the volume control. The prime source of power is the 9-cell nickel-cadmium battery. For mains and car battery operation, this battery is "float charged"

produces no harmful or corrosive fumes, it can be left in a discharged condition for any length of time without ill effect, and it is of rugged, sealed-cell construction which requires no topping up. It is



The Perdio "Portarama" transistorised television set

thus ideally suited for use inside a piece of electronic equipment.

In the "battery" position, the set is wholly powered from the nickel-cadmium accumulator which, when fully charged, will operate the set for at least two hours.

The circuit of the Pye power supply is shown in Fig. 19. The 9-cell battery is protected by a 3A fuse. VC₂ (ganged to VC₁ in the mains input circuit) is the on/off switch, while switches SW₁, 2 and 3 are also ganged to provide the "function".

With the function switch in the "mains" position, power is drawn from the a.c. mains supply via a full-wave rectifier comprising D₁₂ and D₁₃, and sufficient voltage is available to "float-charge" the battery while operating the set. The set will operate indefinitely under this condition.

The battery charging continues with the charge current falling eventually to zero when the e.m.f. of the battery becomes equal to that across the receiver-loaded power supply. Thus, with normal mains operation, the battery remains in the fully-charged condition. In addition to supplying power "on battery", the battery serves to stabilise the power supply in the "mains" position owing to its very low shunt impedance. In this way it also greatly assists in deleting the ripple from the rectified d.c.

Resistor R₃₃ (1.2Ω, 3 watts) is included in series with two of the supply feeds in the "mains" position because the e.m.f. of the battery is somewhat higher than the required 10 volts; the resistor corrects the voltage under this condition.

When the set is operated from a car battery, in the "car" position, the 12 volt car battery acts rather

like the rectified mains-derived power supply, in that the battery "float-charges" the set's internal battery while also working the set. A car battery of average capacity and charge will work the set for a period of some 25 hours.

The Pye also has a fourth position on the function switch, marked "charge". In this position the mains power supply is connected to the battery and the receiver load disconnected. The power unit then acts as an ordinary charger for the battery and is intended to supply a fast overnight charge for the battery when the set is required for portable use the following day.

The red warning lamp, LP₁, indicates that the battery is on charge, and a fully discharged battery takes about fourteen hours to fully charge in this way.

In addition to the smoothing provided by the battery itself, extra smoothing and decoupling is given by the 10,000 μ F electrolytic capacitor on the main output circuit and by the 10,000 μ F electrolytic capacitor and the smoothing choke L₄ on the supply to the horizontal timebase circuits, the latter smoothing also helping to decouple the large timebase currents from the remainder of the circuits.

Regulated Power Supply

As the power consumption of the receiver is continuously changing during normal operation as the result of, for example, changing picture brightness and sound volume, it is essential that the power supply used must be regulated. An ordinary rechargeable battery has a very low impedance across its terminals which means that its output voltage remains substantially constant under varying conditions of load.

Although the impedance of a rectified type of power supply unit operated from the mains supply also has a low impedance, the voltage regulation is nowhere near as good as that given by an

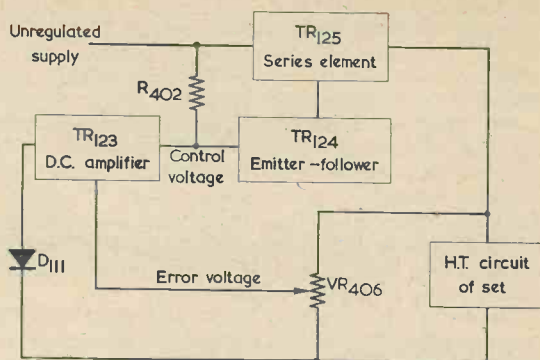

Fig. 20. Block diagram of the regulated power supply used in the Perdio "Portarama" receiver

accumulator, and the terminal voltage will change as the load represented by the receiver changes. This would detract considerably from the performance of the receiver, causing both the picture size to vary in sympathy with the sound and the sound to be affected by variations of the vision signal. To avoid this highly undesirable state of affairs, a mains power supply which does not use the accumulator as a stabilising device must feature some electronic form of voltage control or regulation.

A circuit which provides a useful degree of voltage control, as used in the Perdio "Portarama", is shown in block form in Fig. 20. This is called a "series voltage regulator", and in the state when the voltage supplied to the set is constant (at 11.6 volts in the Perdio set) the circuit works as follows.

A small portion of the voltage applied to the receiver is extracted by way of the potentiometer VR₄₀₆ and fed to the base of a d.c. amplifier transistor TR₁₂₃ (see also the circuit in Fig. 21). This

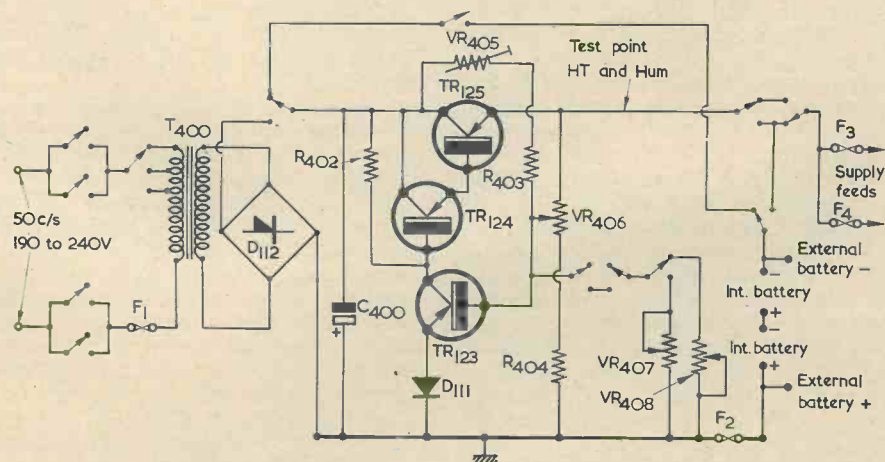

Fig. 21. Circuit details of the Perdio power supply system. This is explained in the text in association with the block diagram in Fig. 20

voltage is compared with a reference voltage at the emitter of TR₁₂₃ due to a zener diode, D₁₁₁.

The resultant voltage, which is produced across the collector load (R₄₀₂) of TR₁₂₃, is applied to the base of an emitter-follower stage, TR₁₂₄. This in turn "drives" a series regulating element, comprising transistor TR₁₂₅. In effect, TR₁₂₅ is an emitter-follower as well, the input to which is the control voltage produced across R₄₀₂.

The emitter of TR₁₂₅ is loaded by the receiver power circuits as a whole, and the output voltage across this load (e.g., across the receiver supply rails) is the regulated supply voltage.

Now, if the receiver load (and hence current consumption) varies and endeavours to change the supply voltage from the pre-set level, a small portion of this voltage change is "sensed" by VR₄₀₆ and fed to the base of the d.c. amplifier TR₁₂₃. This causes a corresponding change of the control voltage across the load R₄₀₂. The change in control voltage (either up or down depending upon the load variation) is transferred to the base of the series element (TR₁₂₅), via the emitter-follower TR₁₂₄, and this causes the current transference between the collector and emitter of TR₁₂₅ to alter in such a manner as to restore the original level of voltage.

In other words, the voltage from the series element transistor is automatically adjusted by the control voltage at its base, and since the control voltage is an amplified sample of the change of voltage due to a changing load condition, the adjustment is such that the voltage output remains very nearly constant despite increasing or decreasing load conditions.

The power proper is derived from a bridge rectifier circuit (D₁₁₂), in which C₄₀₀ (Fig. 21) is the reservoir capacitor. VR₄₀₅ is a kind of feedback control which can be adjusted as a "humdinger" to minimise the hum level. It works by providing a small balancing amount of anti-phase hum feedback to the collector of TR₁₂₅. VR₄₀₆ controls the supply voltage by virtue of adjusting the conditions of the d.c. amplifier TR₁₂₃. In the Perdio set the adjustment is for 11.6 volts.

The power supply circuit also provides facilities for recharging the internal accumulator, with VR₄₀₇ and VR₄₀₈ as the charging rate controls, and for operation from an external 12 volt accumulator.

The Complete Receiver

We have now arrived at the last section in the transistorised television receiver, and the foregoing articles in this series have discussed all the various stages, with illustrations from commercial models. Variations of the circuits described will undoubtedly occur as the transistorised television set becomes more popular; and more popular it is definitely going to become. The days are surely numbered when beach-goers and holiday makers are going to demand no more from their "transistors" than mere sound. Already in the U.S.A. have appeared the "cordless TV" and the "rear-seat auto TV" and, indeed, there are more transistor television receivers operating in Great Britain than may be realised. A number of firms are already producing models,

and at least one set is endowed with ordinary radio facilities over the long, medium and short wavebands.

For portable use, the sets feature a telescopic aerial section loaded to the tuner r.f. amplifier, while an ordinary coaxial input socket is also available for reception of the more distant stations. At v.h.f. transistors have a better noise performance than valves, which really means that the "maximum usable sensitivity" of a transistor set is a few decibels better than that of a valve set.

Based on this principle is a comparatively new transistorised set-top aerial. A dual-band transistor amplifier steps up the signal induced into a special aerial system without adding too much noise. In fact, used with a valve set, the overall noise performance is usually improved. This device allows indoor aerials to be used at distances at least 20% in advance of those normally considered suitable for set-top aerial operation.

U.H.F. transistors are now becoming available, and already a u.h.f. tuner is available. This breakthrough will tend to popularise transistorised television receivers even more, since there would be a limited market if transistors failed to work above v.h.f. now that television in the u.h.f. bands is with us.

Servicing Aspects

It is, of course, impossible to include very much on servicing matters in this article, but transistor receiver servicing may be dealt with later in these pages. One or two points are, nevertheless, worth consideration. Whether we like it or not, all transistor models feature printed circuit boards, and so far the transistors are soldered direct into the circuit, making their removal extremely difficult when it becomes necessary to perform a substitution check. There is a very strong case, especially so far as transistorised television sets are concerned, for transistors to be designed for plugging into sockets on the printed board, like valves. While this technique would probably put a few more shillings on the price of the set, the saving would be many-fold in terms of time during servicing. It is understood that this possibility is under active consideration—so we may yet be able to change transistors like valves!

As sections of a transistorised television set are somewhat miniaturised, the use of small, specially selected tools is essential for efficient and speedy servicing. When removing transistors in particular, a heat-shunt clamped between the component and the printed board on the lead-out wire is a must to avoid damage to a component which has not yet been proved defective. Such tools are now readily available, as also are sub-miniature soldering irons which really get hot at their tips! Concentrated tip-heat for the shortest possible time is the maxim for printed circuit board servicing. Good thermal contact between the soldering iron tip and the soldered joint makes this possible, and this applies in particular when removing a component from the board as well as when replacing one.

A useful "tool" is a large illuminated bench magnifier for locating hairline breaks in the printed

wiring. A good substitute is a fair-sized magnifying glass or reading lens.

To avoid having to rely on the set's battery, a variable regulated power supply unit is a convenient adjunct to the transistor "test bench". These can be made up or purchased commercially. For basic testing a 20,000 ohms/volt multimeter, having a full-scale range of around 12 volts, and sub-multiples and multiples thereof, is useful. The instrument should feature a couple of resistance ranges, from about 50Ω to several megohms, but its internal battery should not be greater than 3 volts. Other-

wise, the forward current in a transistor resulting from a resistance test of the associated circuit may cause damage.

A transistor tester may be of help, and will definitely be of greater help when transistors become plug-in components. There are one or two transistor testers on the market which are designed for testing certain parameters without removing the transistor from the circuit.

Acknowledgements: The author wishes to thank Pye of Cambridge, Perdio Electronics and Global Electronic for their kind help in supplying data and information which has made this series of articles possible.

RADIO TOPICS

ONE OF THE DIFFICULTIES IN designing equipment for home-constructor use, or indeed for mass-production, lies in finding suitable capacitor types for each particular circuit. At the end of the war, believe it or not, there were only three basic types of fixed capacitor in large-scale general use in this country, these being the electrolytic, the paper capacitor and the mica capacitor. Ceramic capacitors were also available at that time but they were, comparatively speaking, something of a rarity, and usually appeared as temperature compensating components in oscillator circuits and in Services equipment operating at v.h.f. and higher frequencies.

Since that time, ceramic capacitors have become available in very large quantities and represent what is almost an inevitable choice for decoupling circuits in the front-ends and i.f. strips of television and f.m. receivers. The lower values also appear in v.h.f. tuning and coupling circuits and, in competition with other types, in circuits operating at lower frequencies. Also appearing since the war have been the polystyrene capacitor (introduced in quantity by Suflex Ltd.) and the polyester capacitor.

When confronted with all these varieties, the problem which faces the equipment designer and the home constructor is: which type should be used for each circuit application?

Choosing a Capacitor

Probably the best way of discussing this question is to deal in turn with the various types of capacitor, starting off with the paper capacitor.

As we all know, one type of paper capacitor consists, essentially, of a

roll comprising two strips of metal foil with paper dielectric sandwiched in between. The two strips of foil then form the plates of the capacitor. The alternative type of paper capacitor employs metallising deposited on the paper instead of metal foil, the whole being rolled up as with the foil version. Because of their rolled construction, paper capacitors offer a large capacitance in a small space, this representing one of their main attractions.

Paper capacitors are low tolerance components, the versions generally available for commercial applications having tolerances of ± 20 or ± 25 % on nominal value. They also have a wide range of temperature coefficients (change in capacitance in parts per million for a rise in temperature of 1°C) according to the grade of dielectric and other factors. Despite these apparent shortcomings, paper capacitors represent an excellent choice for a.f. circuits, where close tolerances on capacitor value are not usually required. They are, also, excellent for a.f. and r.f. decoupling up to some 20 Mc/s or so. In the past, paper capacitors had something of a reputation for developing leakiness with the passage of the years, but this trouble is largely absent with modern versions of the component. Even so, leaky paper capacitors do appear now and again in modern chassis, as most service engineers will confirm.

The mica capacitor is the next component to consider. Some beginners get a little puzzled at the difference between "mica" and "silvered mica" or "silver-mica" capacitors. The mica capacitor employs metal foil for the plates, whilst the silvered mica, or silver-mica, capacitor has a deposit of silvering on the mica itself. Silvered mica capacitors have a higher

stability than mica capacitors and are, in general, to be preferred. In practice, almost all modern wire-ended "mica" capacitors are of the silvered mica type so that, if you order a small "mica capacitor", you are pretty certain to get a silvered mica component in any case. Which is, of course, all to the good.

For home-constructor work, mica capacitors are an excellent choice for circuits operating up to 50 Mc/s or even higher. This fact may surprise those constructors who look upon the region above 20 Mc/s or so as being almost exclusively the domain of the ceramic capacitor. However, if you want to check up on this point, take a look inside the transformer cans on a few 34.65–38.15 Mc/s TV i.f. strips, and see how many silvered mica capacitors you find tuning the i.f. coils!

Silvered mica capacitors are not, nowadays, generally used in values above 1,500pF or so because it is cheaper to employ other types. Apart from their excellent performance over the frequency range I've just mentioned, silvered mica capacitors exhibit the further advantage of having a low and stable temperature coefficient, this being of the order of zero to PO60. (The "P" indicates a positive temperature coefficient, given by an increase in capacitance with rise in temperature.)

Ceramic Capacitors

Ceramic capacitors come next, and it is necessary here for the constructor to realise that these differ from other components in that they have a very wide range of temperature coefficients and tolerances. Low value types, up to about 500pF or so, normally fall into what is known as the low-K category, and they have fixed temperature coefficients varying from P100 to N750, the temperature coefficient depending upon the grade of ceramic employed for the dielectric. (The "N" signifies a decrease in capacitance with rise in temperature.) High value ceramic capacitors,

from about 800pF up, are usually of the high-K type which have very large and non-linear temperature coefficients. Because of the type of ceramic employed as dielectric, high-K capacitors tend to have maximum capacitance at temperatures of the order of 20°C. At temperatures around -40°C they may drop in value by about 25%, and at temperatures around 85°C they may drop in value by as much as 40%. These capacitors employ either the disc or tubular construction and it is safe to assume that, if a ceramic capacitor packs a very large capacitance into a very small space, it will be of the high-K variety and will give large changes in capacitance for variations in temperature. Another point with high-K ceramic capacitors is that they are made with very wide tolerance on value, a figure of -20% +80% being quite common.

The wide range of capacitance (due to tolerance on value and change with temperature variations) which is given by individual high-K ceramic capacitors does not prevent their being used in what is their most useful application: that of r.f. bypass capacitor. Provided an r.f. bypass capacitor has a value which is always greater than a certain minimum figure, that capacitor will always exhibit a reactance equal to or less than that which corresponds to the minimum value. In consequence, the high-K ceramic capacitor provides an excellent choice for all r.f. decoupling circuits up to 250 Mc/s and above, a typical nominal value being 1,000pF. Such capacitors are usually encountered by home-constructors in the disc form but, as I mentioned just now, they are also made in the tubular form as well. Both types function equally well for practically all r.f. decoupling functions, the disc type being usually more convenient since it takes up a little less space.

Because of their high value and small size, high-K ceramic capacitors become very attractive also for anode-to-grid coupling and similar functions in a.f. amplifiers. These capacitors have a high quoted insulation resistance, and there seems no real reason why they shouldn't be used for such applications provided that their wide tolerances and changes in value with temperature are realised. It would probably be best to avoid using them as coupling capacitors to the grids of a push-pull output pair, and for similar circuits where relatively closely matched components are required.

Low-K Capacitors

The low value, low-K ceramic

capacitors (having temperature coefficients between P100 and N750) are close tolerance components which are excellent for r.f. circuits up to 250 Mc/s and above, but their temperature coefficient must always be borne in mind. Despite this it is usually safe, in home-constructor designs, to ignore the temperature coefficient when the capacitor tunes a coil at aerial signal frequency, because the amount of detuning given by change of capacitance as the receiver warms up after switching on is liable to be very low. On the other hand, the use of an incorrect temperature coefficient can cause a lot of trouble if the capacitor has control over receiver oscillator frequency. Most valve oscillator circuits drift on warming up, and the drift is usually in the direction which can be counteracted by a capacitor with a negative temperature coefficient. Because of this, some constructors are tempted to employ, say, an N750 capacitor in the oscillator tuned circuit in order to counteract the drift. The trouble is that such a capacitor can sometimes apply far too much correction whereupon the subsequent drift, in the opposite direction, becomes far worse than that which occurred originally! Unless the constructor can obtain a range of ceramic capacitors with known temperature coefficients and is prepared to carry out the long-winded process of determining which one he requires in his particular circuit, I often feel it is preferable to avoid ceramic capacitors in oscillator tuned circuits altogether unless one is certain that they are P030, NPO or NO30 types. One can then play safe by using silvered mica capacitors instead, designing the receiver so that the oscillator and its components stay as cool as possible after switching on. This applies only, of course, to capacitors which affect the actual oscillator frequency itself.

Incidentally, for those who wish to delve further into this subject, the colour coding employed to indicate temperature coefficient in low value ceramic capacitors was discussed in the "Understanding Radio" article in our June 1962 issue.

The remaining capacitors to deal with are the polystyrene and polyester types. Here, the problem of selection becomes much easier. It is safe, in general, to look upon polystyrene capacitors in rather the same light as silvered mica capacitors. They may be used at frequencies up to about 50 Mc/s and they have a temperature coefficient between about N050 and N200, according to type, plus the attractive feature of an exceptionally high insulation resistance.

Polyester capacitors can be employed at any circuit point where paper capacitors are acceptable and they have a lower dielectric loss than paper types. Also, they are manufactured with a closer tolerance on value, this being, typically, $\pm 10\%$. Both polystyrene and polyester capacitors employ a rolled-up construction which is basically similar to that of the paper capacitor.

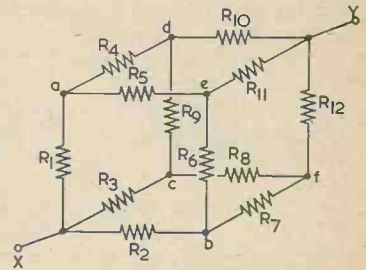

Fig. 1. The cube of resistors. If each resistor has a value of 1Ω, what is the resistance between X and Y?

That Cube of Resistors

Turning from capacitors to resistors, you may recall that, in the December issue, I referred to the cube of resistors which is shown in Fig. 1. Each resistor has the same value (say 1Ω) and the problem is to find the resistance between points X and Y or the total current which flows when a specified voltage is applied to these points.

To demonstrate how the problem may be solved I showed how the cube could be rearranged in symmetrical form, whereupon points of equal potential could be identified and, for the sake of calculation, connected together. My symmetrical network had the disadvantage that three resistors appeared at a slant, and the symmetry was not entirely obvious at first sight without a few words of explanation.

Mr. D. Graves (Rothwell, Leeds) has since sent me an alternative and

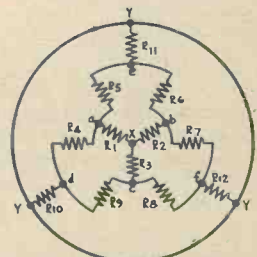

Fig. 2. As demonstrated by Mr. Graves, the cube may be rearranged in the manner shown here.

better version of the rearranged cube, and this exhibits a symmetrical layout which is completely obvious at first sight. I reproduce Mr. Graves's network in Fig. 2. It is at once obvious from this diagram that, if a voltage is applied to X and Y, points (a), (b) and (c) take up the same potential, as also do points (d), (e) and (f). These similar-potential points may, therefore, be joined together for purposes of calculation, whereupon we end up with the network of Fig. 3.

The final resistance of the cube, working from Fig. 3 and assuming that each resistor has a value of 1Ω , is $\frac{1}{3} + \frac{1}{6} + \frac{1}{3} = \frac{2}{3}\Omega$.

Reaction Circuit

Finally, a short note concerning Sir Douglas Hall's article "Simplicity and Sensitivity with Two Transistors", which appears elsewhere in

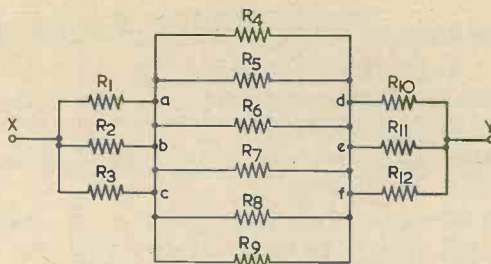

Fig. 3. Connecting points of equal potential together allows the cube to be presented in this simple form

this issue.

Since this article went to press, Sir Douglas has found that a slight but worthwhile improvement can be obtained by adding a $1,000\text{pF}$ capacitor between the "free" end of the

potentiometer and the emitter of TR_1 . This enables oscillation to start near the maximum end of the potentiometer throughout the range and makes the circuit even more efficient.

MAGNETIC RECORDING HEADS TO INDIVIDUAL SPECIFICATIONS

Magnetic recording heads for professional applications are now available to customers' specifications through a new design and manufacturing service announced by Mullard.

Recording heads for tape, magnetic discs and drums can be supplied for either single-track or multi-track applications. Typical uses include video tape-recorders, computers and professional audio-frequency recording equipment.

The heads use a high-density ferrite in place of the conventional laminated-metal construction. As a result, their life expectancy is increased by ten times and they will work at frequencies up to 10 Mc/s . They also have a lower power loss and a lower head noise. By moulding glass in the gap between the pole pieces a sharply defined gap is obtained and erosion of the ferrite at the pole pieces eliminated. Ease of manufacture permits heads to be supplied with gap sizes down to one micrometre.

Queries. We regret that we are unable to answer queries other than those arising from articles appearing in this magazine nor can we advise on modifications to equipment described. Queries should be submitted in writing.

Correspondence should be addressed to the Editor, Advertising Manager, Subscription Manager or the Publishers, as appropriate.

Opinions expressed by contributors are not necessarily those of the Editor or proprietors.

Contributions on constructional matters are invited, especially when they describe the building of particular items of equipment. Articles should be written on one side of the sheet only and should preferably be typewritten, diagrams being on separate sheets. Whether handwritten or typewritten, lines should be double-spaced. Diagrams need not be large or perfectly drawn, as our draughtsmen will re-draw in most cases, but all relevant information should be included. Photographs should be clear and accompanied by negatives. Details of topical ideas and techniques are also welcomed and, if the contributor so wishes, will be re-written by our staff into article form. All contributions must be accompanied by a stamped addressed envelope for reply or return, and should bear the sender's name and address. Payment is made for all material published.

Production.—Letterpress/contact litho.

Published in Great Britain by the Proprietors and Publishers Data Publications Ltd. 57 Maida Vale London W9

Printed by A. Quick & Co. (Printers) Ltd. Oxford Road Clacton-on-Sea England

Obtainable abroad through the following Collets Subscription Service Continental Publishers & Distributors Ltd William Dawson & Sons Ltd. Australia and New Zealand Gordon & Gotch Ltd. Electronics Publications (Australia) South Africa Central News Agency Holland "Radio Electronica"

THE MODERN BOOK CO

Short Wave Amateur Radio. By J. Schaap. 21s. Postage 1s.

Understanding Television. By J. R. Davies. 37s. 6d. Postage 2s.

Colour Television Explained. By W. A. Holm. 21s. Postage 1s.

Disc Recording and Reproduction. By P. J. Guy. 42s. Postage 1s.

Radio Servicing Problems. By W. A. L. Smith. 5s. Postage 6d.

Tape Recording and Reproduction. By A. A. McWilliams. 42s. Postage 1s.

Radio Valve Data, 7th ed. Compiled by "WW". 6s. Postage 10d.

Circuits For Audio Amplifiers. By Mullard. 8s. 6d. Postage 1s.

The Radio Amateur's Handbook, 1964. By A.R.R.L. 36s. Postage 2s. 6d.

Tape Recorders—How They Work. By C. G. Westcott & R. F. Dubbe 24s. Post. 1s.

Basic Industrial Electronics Course. By A. Haas. 30s. Postage 1s.

Getting Started With Transistors. By L. E. Garner, Jr. 28s. Postage 1s.

Radio Servicing Pocket Book. By J. P. Hawker. 12s. 6d. Postage 6d.

Basic Mathematics For Radio and Electronics. By F. M. Colebrook and J. W. Head. 17s. 6d. Postage 1s.

Electronics For The Beginner. By J. A. Stanley. 25s. Postage 1s.

Amateur Radio Call Book. By R.S.G.B. 1964 ed. 4s. 6d. Postage 6d.

We have the Finest Selection of British and American Radio Books in the Country
Complete Catalogue 1s.

19-21 PRAED STREET (Dept RC) LONDON W2

Telephone PADDington 4185

FREE THIS BOOK WILL INTEREST YOU!

LEARNING the PRACTICAL WAY



FOR ... Your Career
... Your Own Business
... An Absorbing Hobby

Radiostructor
EQUIPMENT-COURSES

A NEW-PRACTICAL WAY of UNDERSTANDING

RADIO • TELEVISION • ELECTRONICS

Including: Transistors; VHF/FM; Hi-Fi Equipment; Computers; Servo-Mechs. Test Instruments; Photo-electrics; Nucleonics; etc.

Radiostructor—an organisation specialising in electronic training systems—offers a new self-instructional method using specially designed equipment on a "do-it-yourself" basis. You learn by building actual equipment with the big kits of components which we send you. You advance by simple steps, performing a whole series of interesting and instructive experiments—with no complicated mathematics! Instructional manuals employ the latest techniques for showing the full story of electronics in a practical and interesting way—in fact, you really have fun whilst learning!

RADIOSTRUCTOR
LEADS THE WORLD
IN ELECTRONICS TRAINING

POST NOW

To RADIOSTRUCTOR (Dept. G149), READING, BERKS.
Please send brochure, without obligation, to:

*Name _____

*Address _____

(We do not employ representatives) 3/64
*Block Caps Please

SMALL ADVERTISEMENTS

Rate: 9d. per word.

Minimum charge 12/-.

Box No. 2/- extra.

Advertisements must be prepaid and all copy must be received by the 4th of the month for insertion in the following month's issue. The Publishers cannot be held liable in any way for printing errors or omissions, nor can they accept responsibility for the bona fides of advertisers. (Replies to Box numbers should be addressed to: Box No. —, *The Radio Constructor*, 57 Maida Vale, London, W.9.)

DIRECT TV REPLACEMENTS LTD. Largest stockists of TV components in the U.K. Line output transformers, Frame output transformers, Deflector coils for most makes. Official sole suppliers for many set makers. Same day despatch service. Terms C.O.D. or C.W.O. Send S.A.E. for quotes. Day and night telephone: Gipsy Hill 6166.—126 Hamilton Road, West Norwood, London, S.E.27.

THE INCORPORATED PRACTITIONERS IN RADIO AND ELECTRONICS (I.P.R.E.) LTD. Membership conditions booklet 1s. Sample copy of I.P.R.E. Official Journal 2s. post free.—Dept. D, Secretary, 32 Kidmore Road, Caversham, Reading, Berkshire.

SERVICE SHEETS for all makes Radio/TV, 1925-1963. Prices from 1s. with free fault-finding guide. Catalogue 6,000 models, 1s. 6d. S.A.E. enquiries. All types of modern/obsolete valves. Books. Components. S.A.E. lists.—Hamilton Radio, 13 Western Road, St. Leonards, Sussex.

CATALOGUE No. 15. Government surplus electrical and radio equipment. Hundreds of items at bargain prices for the experimenter and research engineer, 2s. 6d. post free. Catalogue cost refunded on purchase of 50s.—Arthur Sallis Radio Control Ltd., 93 North Road, Brighton.

S.E.S. SERVICE SHEETS for all TV, Radio, including transistors, tape recorders, echo units, amplifiers, record players, autochangers, etc. Also various domestic appliances. List 1s. S.A.E. Mail order only.—Sun Electrical Services, 38 St. George's Road, Hastings.

METALWORK. All types cabinets, chassis, racks, etc., to your specifications.—Philpott's Metalworks Ltd., Chapman Street, Loughborough.

BRAND NEW Standing Wave Indicators IM-81/UP with instructions. Described in *Radio Constructor*, January 1964, £5, P.P. 15s.—EWS Co., 69 Church Road, Moseley, Birmingham. Letters only.

TRANSISTORS, 100% Red or White Spots, 1s. each. OC44/5, OC71, OC81, 3s. 6d. each; OC170, OC171, AF117, 4s. each; OC26, 10s. each. 1,001 other snips. S.A.E. list.—Cursons, 78 Broad Street, Canterbury, Kent.

FIND TV SET TROUBLES IN MINUTES from that great book *The Principles of TV Receiver Servicing*, 10s. 6d., all book houses and radio wholesalers. If not in stock, from—Dept. D, Secretary, 32 Kidmore Road, Caversham, Reading, Berkshire.

BENTLEY ACOUSTIC CORPORATION LTD

38 CHALCOT ROAD CHALK FARM LONDON NW1
THE VALVE SPECIALISTS Telephone PRIMROSE 9090
ALL GOODS LISTED BELOW IN STOCK

OA2	4/6/630L2	8/3/AC/TP	18/-EL42	7/6/PY81	5/-MIDGET
OB2	6/1/756	12/6/AZ1	5/9/EL81	8/3/PY82	4/9/SILICON
OZAGT	4/3/787	7/-AZ31	6/6/ELB3	6/9/PY83	5/9/RECTIFIERS
IA7GT	7/9/7C5	7/3/AZ41	6/6/EL84	4/9/PY88	7/9/Mullard
IC5	6/3/7C6	6/9/B36	4/9/EL85	7/6/PY800	6/6/BY100
IG6	6/-7H7	5/9/BL63	10/6/EL86	2/6/R10	26/6/Output 250
IHSGT	7/9/7R7	12/6/CH35	12/6/EL91	5/6/R19	6/6/volt at ±
IL4	2/3/757	14/6/CL33	11/6/EL95	5/6/R19	9/-amp. No lar-
ILD5	4/-7Y4	5/-CY31	5/9/EL360	27/-T41	8/-ger than a
ILN5	4/6/9BW6	9/6/DAF96	5/9/EL220	16/4/TDD4	6/9/shirtbutton
INSGT	8/6/9D7	7/6/DF66	15/-ELL80	20/5/TH233	17/6/each
IR5	4/-10C1	9/3/DF96	5/9/EM4	11/6/TY86	11/8
IS4	5/-10C2	12/3/DF97	10/-EM34	11/6/TY86	11/8
IS5	3/6/10D2	10/6/DH76	3/6/EM71	13/6/UL12/4	7/6/TRANSIS-
IT4	2/3/10F1	10/-DK40	15/6/EM80	6/3/UL8/20	6/6/TORS &
IU4	5/6/10LD11	9/6/DK92	6/9/EM81	7/-U19	48/6/DIODES
IU5	5/3/10P13	11/6/DK96	6/3/EM84	6/9/U22	5/9
2D21	5/6/10P14	11/6/DL68	15/-EM85	8/9/U24	12/6/AA129 4/6
2X2	3/-12A6	6/3/DL96	5/9/EM87	7/6/US25	8/6/AC107 14/6
3A4	3/9/12A6C5	8/6/DLS10	10/6/EN34	10/-U26	7/6/AC127 9/6
3B7	5/-12A6E	8/-DY86	7/6/EY51	5/9/US31	6/9/AD140 25/-
3D6	3/9/12AH8	9/-EB0F	24/-EY83	9/3/US35	16/6/AF102 27/6
3Q4	5/3/12AT6	4/6/EB3F	24/-EY84	9/6/US37	16/6/AF114 11/6
3Q5	7/-12AU6	5/9/EB8CC	10/-EY86	5/9/US45	15/6/AF116 10/-
3S4	4/6/12AV6	6/6/EB8F	10/-EY88	8/9/US76	4/6/AF117 5/6
3V4	5/3/12BA6	5/9/EABC80	5/6/EZ40	5/3/US91	9/6/AF118 20/-
5R4GY	8/6/12BE6	4/9/EAC91	3/3/EZ41	6/-U282	12/3/AF127 9/6
5T4	7/-12BH7	6/9/EAF42	6/9/EZ80	4/-U301	11/3/BY213 11/6
5U4G	4/6/12J7GT	7/3/EB41	4/9/EZ81	4/-U329	9/-MAT100 7/9
5V4G	7/6/12K5	10/-EB91	2/3/EZ82	3/6/US33	17/6/AT101 8/6
5Y3GT	4/3/12K7GT	3/6/EB91	6/6/GZ33	17/6/U404	6/-MAT120 7/9
5Z3	7/-12K8GT	9/-EBC81	5/9/GZ34	10/-U801	16/3/MAT121 8/6
5Z4G	7/-12Q7GT	3/6/EBF80	5/6/GZ37	14/6/U4020	6/6/OA5 6/6
6A8G	5/9/12SA7	6/9/EBF83	7/3/HABC80	9/3/UABC80	5/-OA10 8/-
6AG5	2/6/12SC7	4/-EBF89	6/3/HL1DD	8/6/UA42	7/-OA70 3/6
6AG7	5/9/12SK7	3/-EBl21	8/-HL2CD	8/6/UB4H1	6/3/OA73 3/6
6AK5	4/9/12SQ7	9/-EB309	25/-UBC81	6/3/OA79	3/6
6AQ5	5/9/12ST	19/6/EC81	27/6/HV2	8/3/UBF80	5/9/OA81 3/6
6AT6	3/9/19AQ5	7/3/EC92	6/6/HV2A	8/9/UBF89	6/9/OA85 3/6
6AU6	5/3/19H1	6/-ECC32	4/-KT33C	4/-UBL21	9/9/OA86 4/6
6AV6	5/6/20D1	10/-ECC34	21/7/KT36	29/1/UC92	6/3/OA90 3/6
6BG6	2/6/20F2	11/6/EC35	5/-KT41	7/6/UC84	8/9/OA91 3/6
6BA6	4/6/20L1	12/6/ECC40	7/-KT61	6/9/UC85	6/3/OA95 3/6

We require for prompt cash settlement all types of valves, loose or boxed, but must be new. Send list of types available for offer by return.

6B6E	4/9/20P1	12/6/EC81	3/6/KTW61	4/9/UCF80	8/9/OA210 9/6
6BH6	5/3/20P3	12/-ECC82	4/6/KTW62	5/6/UCH21	8/3/OA211 8/6
6B16	5/6/20P4	13/6/EC83	4/6/KTW63	5/6/UCH42	7/-OC16W35 5/6
6BQ7A	7/6/20P5	12/3/EC84	5/9/KT66	12/3/UCB81	6/3/OC19 25/-
6BR7	8/6/25AG	7/6/EC85	4/3/KT88	28/-UCL82	8/9/OC22 23/6
6B8R	8/6/25L6GT	6/-ECC88	10/-MKT4	17/6/UCL83	8/6/OC23 57/6
6BW6	6/9/25Z4G	6/6/ECC189	11/6/MU14	4/6/UF41	6/9/OC25 12/6
6BW7	5/-25Z5	7/3/ECC804	16/4/N78	26/-UF42	7/6/OC26 25/6
6C5	4/-27S4	23/3/ECF80	6/-N339	15/-UF80	6/3/OC29 18/6
6C9	10/9/28D7	6/9/ECF82	6/3/PABC80	6/9/UF86	9/-OC36 21/6
6CD6G	18/-30C15	9/6/ECF86	11/6/EC86	10/3/UF86	9/-OC31 8/6
6CH6	5/3/30C18	10/6/ECH21	9/9/PC88	14/7/UF89	6/-OC41 8/6
6D3	9/6/30F5	5/9/ECH35	6/3/PC95	11/8/UL41	6/9/OC42 5/6
6D6	3/-30FL1	9/3/ECH42	7/6/PC97	7/9/UL44	23/3/OC43 12/6
6E5	9/6/30FL12	11/-ECH81	5/9/PC84	5/6/UL46	8/6/OC44 8/6
6F1	9/6/30L15	9/3/ECH83	6/6/PC85	6/9/UL49	6/3/OC44P11/6
6F6G	3/9/30P4	12/3/ECB84	4/6/PC88	10/6/UM4	15/2/OC45 8/6
6F12	9/6/30P12	7/6/EL80	6/-PCC89	7/9/UM34	16/10/OC45P110/6
6F23	9/-30P19	12/3/ECL82	9/6/PC8189	10/6/UM80	8/6/OC65 22/6
6F24	9/6/30PL1	8/6/ECL83	9/6/PCC80	5/6/URIC	6/3/OC66 25/6
6F33	3/6/30PL13	9/6/ECL86	8/6/PCF82	6/3/UL6	9/-OC70 6/6
615G	3/-30PL14	12/6/EF22	6/6/PCF84	8/6/UL8	11/6/OC71 3/6
616	3/-35A5	20/9/EF36	3/3/PCF86	7/9/UY1N	10/3/OC72 8/6
617G	4/6/35L6GT	6/9/EF37A	6/6/PC82	6/6/UY21	8/-OC73 16/6
6K7G	1/3/35W4	4/9/EF39	3/9/PC83	7/9/UY41	4/6/OC74 8/6
6K8G	3/3/35Z3	16/4/EF40	8/9/PC84	7/-UY85	5/-OC75 8/6
6K25	24/-35Z4GT	4/6/EF41	6/9/PC85	7/6/VP4	14/6/OC76 8/6
6L1	10/-35Z5GT	5/9/EF42	4/9/PC86	8/9/VP4B	20/5/OC77 12/6
6L6G	6/6/50C8	6/6/EF73	5/-PCL88	12/6/VP3C	7/-OC78 4/6
6L7GT	4/6/50L6GT	6/3/EF70	3/9/PEN46	4/3/VP23	2/6/OC81 8/6
6LD20	5/6/72	6/6/EF85	4/9/PEN383	10/3/VP133	9/9/OC814 4/6
6N7GT	5/-77	5/-EF86	6/-PL36	8/-VR105	5/6/OC82 10/6
6P28	11/6/78	4/9/EF89	4/-PL38	16/-W76	4/9/OC83 6/6
6O7G	4/6/80	5/3/EF91	3/-PL31	6/9/W81M	5/9/OC139 12/6
6R7G	5/9/85A2	8/6/EF92	2/6/PL82	5/3/X41	15/-OC140 8/6
6S7	5/3/90AG	6/7/EF97	11/6/PL83	5/3/X61	6/3/OC170 19/6
6S7N	4/-90AV	6/7/EF98	10/-PL84	5/6/X65	5/6/OC171 9/6
6U4GT	8/6/90CG	42/-EF183	7/9/PM84	9/3/X66	7/3/OC200 10/6
6U5G	5/-90CV	42/-EF184	7/9/PX4	9/-X76M	9/-OC201 2/6
6U7G	7/-90C1	16/-EK32	5/9/PX25	8/6/X78	20/6/OC203 14/6
6V6G	3/9/150B2	16/6/EL32	3/6/PY31	6/-X79	20/6/OC271 17/6
6V6GT	5/6/185BT	34/11/EL33	6/9/PY32	8/6/XH(1.5)	6/6/TS2 12/6
6X4	3/9/5763	7/6/EL34	8/6/PY33	8/9/Y63	5/-TS3 15/6
6X5	4/6/AC6PEN	4/9/EL41	7/3/PY80	5/-Z66	7/3/XA103 15/6

All goods new and first grade only, subject to makers' full guarantee. We do not sell second-hand goods, manufacturers' rejects or seconds (often described as "new and tested!"), nor items from second-hand equipment. Complete catalogue of over 1,000 valves, also resistors, condensers, metal rectifiers, microphones, loudspeakers, etc., with conditions of sale, 6d.

Terms of business: Cash with order or C.O.D. only. Posts/packing 6d. per item. Orders over £3 post free. C.O.D. 3/6 extra. All orders despatched same day. C.O.D. orders by telephone accepted for immediate despatch until 3.30 p.m. Any parcel insured against damage in transit for 6d. extra. We are open for personal shoppers 8.30-5.30. Sats. 8.30 a.m.-1 p.m.

continued on page 645



BRITISH OLYMPIC APPEAL FUND—1964
WIN THE BRITISH OLYMPIC ASSOCIATION'S
'TRIP TO TOKYO'
CONTEST

Three separate, wonderful prizes of all-expenses-paid trips for two for the fortnight of the 1964 Olympic Games must be won. Each prize includes return flights to Tokyo in B.O.A.C.'s magnificent new V.C. 10, first-class hotel accommodation, tickets for a selected programme of Olympic Games events and £20 spending money—or you can take a cash prize of £750.

CHOOSE EIGHT FROM THESE

- A.** More professional coaches.
- B.** More mixed clubs for adults, offering various sports and social activities.
- C.** Offices and paid administrative staff for all sports.
- D.** More medical research into sports problems.
- E.** More sports facilities for the general public.
- H.** Better arrangements made for school leavers to join sports clubs.
- J.** More International sports events.
- K.** More sports activities and facilities in schools.
- N.** More funds available to pay legitimate expenses of competitors.
- R.** Grants to ensure better use of existing sports facilities.
- S.** More commercial sponsorship of sport.
- T.** More Government financial aid for sport.

ALL YOU DO

Here are twelve suggestions designed to lead to the best possible performance by the Great Britain team at the 1968 Olympic Games. Use your skill to select **EIGHT** suggestions likely to be of the greatest benefit and place them in order of importance.

Print the identity letters of your selections in the appropriate places in the first downward column of the entry form. The other columns are for additional attempts.

You may make up to a maximum of 12 attempts on each entry form, and send as many official entry forms as you like. A donation of 3d. to the Olympic Appeal Fund must be sent for every attempt and a donation of 3/- will entitle you to twelve attempts.

A panel of judges will award the prizes to the senders of the three entries they consider best. In the event of ties, an eliminating contest will be held. A copy of the full rules may be obtained by sending a s.a.e. to the organisers of the contest.

The Judges, and Members of the B.O.A. Council and employees of the B.O.A., their agents and I.C.T Ltd.—and their families, are not eligible to enter.

All winners will be notified by post.

CLOSING DATE FOR ENTRIES—27th JUNE, 1964.

----- CUT HERE -----

ENTRY FORM	Col. 1	Col. 2	Col. 3	Col. 4	Col. 5	Col. 6	Col. 7	Col. 8	Col. 9	Col. 10	Col. 11	Col. 12
1st choice												
2nd choice												
3rd choice												
4th choice												
5th choice												
6th choice												
7th choice												
8th choice												
DONATIONS ▶	3d.	3d.	3d.	3d.	3d.	3d.	3d.	3d.	3d.	3d.	3d.	3d.

Entries in a sealed envelope (3d. postage) must be sent to :—
"TRIP TO TOKYO" CONTEST, P.O. Box 27/4000, LONDON, W.1.

NAME (Mr./Mrs./Miss)

ADDRESS

To cover the above entries I enclose cheque/P.O. value
 and I agree to abide by the rules of the contest.

Send crossed postal order or cheque payable to the "Trip to Tokyo" Contest.

**Donations — after deduction of expenses — will go
 towards the £150,000 needed to send the British Team to the 1964 Olympic Games**

ALL ENTRIES WILL BE CHECKED BY AN I.C.T COMPUTER

SMALL ADVERTISEMENTS

continued from page 643

FOR DISCERNING ENTHUSIASTS. Prompt Service. High quality transistors and components. Postage free over 10s., otherwise 6d. please. C.W.O. Mullard high grade industrial semiconductors BY100 now 11s 6d., OC171 9s., OC45, OC41, OC84 8s. Texas and RCA transistors to order. Mesa, silicon planar, tunnel diodes, etc. Please send s.a.e. for list.—J. Williams & Co., 208 Hagley Road, Birmingham 16.

FOR SALE. Mohican transistor communications receiver with batteries, manual. Mint condition, factory aligned and tested. £32 for quick sale.—Box No. F193.

FOR SALE. Quantity of new accumulators. Willard Radio-20-2, 2 volt, 5s. each, plus carriage.—Box No. F199.

FOR SALE. Partially completed model R/C patrol torpedo boat, 40in. in length, 11in. beam. "Aerokit" kit. Marine Taplin Twin, twin rudders with steering motor and throttle control installed. Needs superstructure and R/C completing. £25 o.n.o.—Box F201.

FOR SALE. Valve instrument tester's VT5, new £12, or part exchange test gear. S.A.E.—R. C. Molineux, Lowfield Heath, Crawley, Sussex.

WANTED. *Wireless World* Vol. 67, Nos. 11 and 12 (1961) and issues of June, July and August 1963. Telephone ELMbridge 9514 after 6 p.m.

WANTED. *Newnes Radio and TV Servicing* up to 1963. State price and condition.—Box No. F203.

CONVERT ANY TV SET INTO AN OSCILLOSCOPE. Instructions and diagrams, 12s. 6d.—Box No. F204.

COLLECTOR interested in purchasing really early wireless valves—First World War or earlier. Has for disposal numerous mid-1920s types. Also for sale several early crystal detectors.—Enquiries to Box No. F205.

PANEL SIGNS TRANSFERS—NEW SERIES. Set 3 Wording—White. Set 4 Wording—Black. Set 5 Dials—one large and two medium scales, horizontal tuning scale, control panels (switches, potentiometers and variable capacitors) having white markings on a clear background. Set 6 Dials—as in Set 5, but the control panels have white markings on a black background. All sets 4s. 6d. each, postage 3d. Limited supply of Set 2 of the old series (Test Equipment—scales, control panels and some white wording) still available, price 3s. 6d., postage 3d.

INTERESTED IN AMATEUR RADIO TELEPRINTING? Then join the British Amateur Radio Teleprinter Group. Details from Hon. Sec., G2UK, East Keal, Romany Road, Oulton Broad, Suffolk.

Continued on page 647

RETURN-OF-POST SERVICE

ON CASH OR C.O.D. ORDERS

● LATEST TEST METERS

	Cash Price	Hire Purchase	Deposit	Mthly Pmts.
AVO Model 8, Mark II ...	£24. 0.0	£4.16.0	12 of	£1.15. 2
AVO Model 7, Mark II ...	£21. 0.0	£4. 4.0	12 of	£1.10.10
AVO Multiminor Mark IV ...	£9.10.0	£1.18.0	12 of	14/4
T.M.K. TP10 ...	£3.19.6	£1. 3.6	3 of	£1. 2. 0
T.M.K. TP55 ...	£5.19.6	£1.15.6	3 of	£1.11. 4
T.M.K. Model 500 ...	£8.19.6	£1.15.6	12 of	13/8
TAYLOR Model 127A ...	£10.10.0	£2. 2.0	12 of	15/8

Full details of any of the above supplied free on request. The AVO Models 7 and 8 are both latest models from current production—not to be confused with Government surplus.

● GRAMOPHONE EQUIPMENT

ALL LATEST MODELS ALL POST FREE	Cash Price	Hire Purchase	Deposit	Mthly Pmts.
RECORD CHANGERS				
GARRARD AUTOSLIM (Mono PU) ...	£6.17.6	£1.12.6	6 of	£1. 0. 0
GARRARD AUTOSLIM De-luxe AT6 (Mono PU) ...	£11. 9.0	£2. 6.0	12 of	16/11
GARRARD AUTOSLIM AT6 (Stereo/Mono PU) ...	£12. 5.4	£2. 9.4	12 of	18/-
B.S.R. UA14 (TC8 Mono PU) ...	£6.15.0	£1.10.0	6 of	£1. 0. 0
B.S.R. UA14 Monarch (TC8 Stereo/LP/78) ...	£7.15.0	£1.18.0	6 of	£1. 2. 0
B.S.R. UA15 (TC8 Mono PU) ...	£7.15.0	£1.18.0	6 of	£1. 2. 0
B.S.R. UA15 (TC8 Stereo/LP/78) ...	£8.15.0	£2. 6.0	6 of	£1. 4. 0
SINGLE RECORD PLAYERS				
B.S.R. TU12 (TC8 Mono PU) ...	£4. 1.3	£1. 5.3	3 of	£1. 2. 0
B.S.R. GU7 (TC8 Mono PU) ...	£4.18.8	£1. 8.8	3 of	£1. 6. 8
GARRARD SRP10 (Mono PU) ...	£5.9.11	£1.12.11	3 of	£1. 9. 0

Many of the above can be supplied for stereo working. See our Gramophone Equipment List for details.

● TAPE RECORDING EQUIPMENT

ALL CARRIAGE FREE	Cash Price	Hire Purchase	Deposit	Mthly Pmts.
COLLARO STUDIO. Latest model. Two track. Brad-matic Heads ...				
Four Track, Mariott Heads ...	£10.19.6	£2. 3.6	12 of	16/4
Four Track, Mariott Heads ...	£17.17.0	£3.12.0	12 of	£1. 6. 2

MARTIN TAPE AMPLIFIER KITS
Tape Amplifiers
For Collaro 8311-V 2-Track £11.11.0 8311-4-V 4-Track £12.12.0
Tape Pre-Amplifiers
For Collaro 8312-CP 2-Track £8. 8.0 8312-4-CP 4-Track £9. 9.0
Drop through assembly for mounting 8312 Pre-Amp under Collaro Deck, £1.11.6
Carrying Cases with speaker. For Collaro Deck and 8311 Amplifier, £5.5.0

H.P. TERMS available on decks, amplifiers and cases. Ask for quote.
SPECIAL OFFER! STEREO CARTRIDGES
RONETTE 105 Stereo/Mono P.U. Cartridge. Complete with fixing bracket and stylus. List 59/4. OUR PRICE 23/6 Post Free.

● JASON F.M. TUNERS

We stock all parts needed for the construction of these excellent tuners. All parts can be supplied separately but we can offer attractive reductions in price if all items are purchased at same time as follows:
FMT1 ... £6.12.6 FMT2 (less power) ... £7.15.0
FMT2 (with power) ... £9.12.6 FMT3 (less power) ... £9. 9.6
FMT3 (with power) ... £11. 7.6 Mercury 2 ... £10.14.6
JTV/2 ... £14.12.6
Hire Purchase Terms available. Ask for list.

● AMPLIFIER KITS

We have full stocks of all components for the Mullard 510, Mullard 3-3, Mullard 2, and 3 Valve Pre-Amp, Mullard Stereo, Mullard Mixer. Fully detailed list on any of these sent upon request.
Instruction Manual: All Mullard Audio Circuits in "Circuits for Audio Amplifiers", 9/5. Post Free.

● MARTIN AUDIO KITS

High quality Transistor Amplifying Equipment. Following units now available: Input Selector Unit £2.7.6; Pre-Amplifier with Volume Control £1.17.6; Mixer Unit £3.19.6; Pre-Amplifier with Tone Control £3.2.6; 10 watt Main Amplifier £5.12.6; Power Supply Unit £2.12.6. Fully detailed literature available.
H.P. Terms on any combination of units—ask for quotation.

● ILLUSTRATED LISTS

Illustrated lists are available on LOUDSPEAKERS, TAPE DECKS, TEST GEAR, GRAMOPHONE EQUIPMENT, AMPLIFIERS. Any will be sent free upon request.

WATTS RADIO (MAIL ORDER) LTD

54 CHURCH STREET WEYBRIDGE SURREY

Telephone Weybridge 47556

Please note: Postal business only from this address
Callers welcome by appointment

★ **TERMS OF BUSINESS** Cash with order or C.O.D. We charge C.O.D. orders as follows: Up to £5 minimum of 4/2. Over £5 and under £10, 2/8. Over £10, no charge. Postage extra on CASH orders under £5 except where stated. Postage extra on overseas orders irrespective of price.

★ **HIRE PURCHASE TERMS** available on many items. Send for quotation.

An Exciting New Project!



BUILD
a complete
**TRANSISTORISED
C.C.T.V. CAMERA!**

Buy it and build it in easy stages with the famous BEUKITS—Kit No. 1 £18.17.6. Spec., principles of vidicon tube, scanning assembly and optical system diagram. Kit No. 2 £16.10.0. Printed circuit board and assoc. components, circuit, diagram, layout instructions and Manual. Kit No. 3 £8.0.0. All transistors and semi-conductors. Kit No. 4 £6.0.0. All metal work. Plus 7/6 P. & P. for each kit. (Kits cannot be split. Inst. Manual cannot be supplied separately).

...and get the most out of it
with a genuine
BEUKIT!

Kit, less Vidicon
and lens
**ONLY
£48**
p. & p. 7/6

As specified by Radio Constructor.
Also available factory assembled and tested, with vidicon, less lens, 69 gns.; or with lens and vidicon, 79 gns. Lens with fixed iris £11. E.M.I. Experimenters' Type Vidicon Tube 10667M £12. Free literature from:

**BEULAH ELECTRONICS DEPT. R.C., 126 HAMILTON ROAD,
WEST NORWOOD, LONDON, S.E.27. Telephone GIP 6166 (PBX)**

**FREE
BLUEPRINT**

to build 35-watt
**GUITAR
AMPLIFIER**

ALSO IN THE MAY ISSUE

Build a Six-band T.R.F. Receiver.
Radio Communication through the Ground.
Ferrite Rod Aerial Data.

INSIDE

**PRACTICAL
WIRELESS**

MAY ISSUE — ON SALE APRIL 7th — 2/-

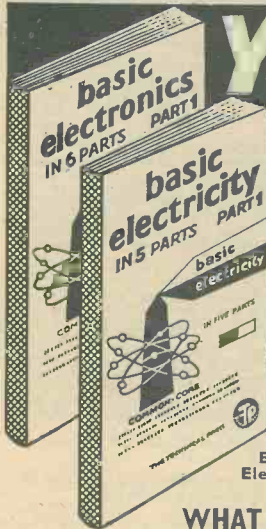

YOURS FREE FOR 7 DAYS

The New 'Picture-Book' way of learning
**BASIC ELECTRICITY (5 VOLS.)
BASIC ELECTRONICS (6 VOLS.)**

You'll find it easy to learn with this outstandingly successful new pictorial method—the essential facts are explained in the simplest language, one at a time; and each is illustrated by an accurate, cartoon-type drawing.

The books are based on the latest research into simplified learning techniques. This has proved that the Pictorial Approach to learning is the quickest and soundest way of gaining mastery over these subjects.

The series will be of exceptional value in training mechanics and technicians in Electricity, Radio and Electronics.

WHAT READERS SAY

"Learnt more in Part 1 than the previous 2 years."—L.M.J., Durham. "I am convinced that I am on to something really worth while."—J.L.P., Fife. "Without doubt they are the easiest to follow books I have ever studied."—W.J., Aylesbury. "Congratulations on a well-planned easy-to-learn series."—M.K., Horsham. "First class, I cannot praise them too highly."—J.J., Taunton.

A TECHNICAL PRESS PUBLICATION

POST NOW FOR THIS OFFER!!

To Selray Book Co.

60 Hayes Hill, Hayes, Bromley, Kent

Please send me **Without Obligation to Purchase**, Basic Electricity/Basic Electronics on 7 Days Free Trial. I will either return set, carriage paid, in good condition within 8 days or send down payment of 10/- (Basic Electricity) followed by 6 fortnightly payments of 10/-; Down payment of 12/- (Basic Electronics) followed by 6 fortnightly payments of 12/-. Alternatively, I will send 63/- (Basic Electricity—5 parts), 75/- (Basic Electronics—6 parts) post free. This offer applies to United Kingdom only.

Tick against set required (only one set allowed on free trial)

BASIC ELECTRICITY **BASIC ELECTRONICS**

Signature _____
(If under 21, signature of parent or guardian)

Block letters below

Name _____
Full Postal Address _____

R.C.4

SMALL ADVERTISEMENTS

Continued from page 645

JOIN THE INTERNATIONAL S.W. LEAGUE. Free Services to members including Q.S.L. Bureau. Amateur and Broadcast Translation. Technical and Identification Dept.—both Broadcast and Fixed Stations, DX Certificates, contests and activities for the SWL and transmitting members. Monthly magazine, *Monitor*, containing articles of general interest to Broadcast and Amateur SWLs, Transmitter Section and League affairs, etc. League supplies such as badges, headed notepaper and envelopes. QSL cards, etc., are available at reasonable cost. Send for League particulars. Membership including monthly magazine, etc., 21s. per annum.—Secretary, ISWL, 12 Gladwell Road, London, N.8.

THE INTERNATIONAL HAM HOP CLUB is a non-profit-making organisation open to RADIO AMATEURS AND SHORT WAVE LISTENERS. OBJECT: to improve international relationships through an organised system of hospitality. MEMBERS offer overnight hospitality to visiting members, subscription 10s. per annum. ASSOCIATE MEMBERS invite radio amateurs to visit their stations. Associate membership 5s. per annum. FAMILY EXCHANGE holidays arranged, also FRIENDSHIP LINKS between radio clubs. The Club's official journal is free to both Full and Associate Members.—Hon. Gen. Secretary: G. A. Partridge, G3CED, 17 Ethel Road, Broadstairs, Kent.

SITUATIONS VACANT

TEST ENGINEERS

for telephone answering machines. Basic knowledge of tape recorders and transistors is essential. Starting salary £825 to £900 per annum.

ROBOPHONE LIMITED

Beulah Works, Beulah Road, Thornton Heath. LIV 2278/9

TV FAULT FINDING DATA BOOK SERIES NO. 5

Contains information and fault finding details of both the B.B.C. and I.T.A. transmissions. Lavishly illustrated by photographs taken from the screen of a television set exhibiting the faults under discussion. A comprehensive fault finding guide is included, and this is cross referenced to the book itself.

Over 100 Illustrations and Diagrams

104 pages, high quality paper with laminated plastic board cover

Price 5/- Postage 5d.

Available from your usual supplier, or direct from

DATA PUBLICATIONS LTD
57 Maida Vale London W9

PRICE LISTS & INFORMATION ON

Various Designs in

Practical Wireless	Radio Constructor	Wireless World	R.S.G.B. Bulletin
-----------------------	----------------------	-------------------	----------------------

KINDLY NOTE
CHANGE OF ADDRESS

OSMOR

FACTORY AND OFFICES

540 PURLEY WAY

(Near Airport)

GROYDON, SURREY

Telephone: CRO 5148/9

YOUR CAREER IN RADIO?

Big opportunities and big money await the qualified man in every field of Electronics today—both in the U.K. and throughout the world. We offer the finest home study training for all subjects in radio, television, etc., especially for the CITY & GUILDS EXAMS. (Technicians' Certificates); the Grad. Brit. I.R.E. Exam.; the RADIO AMATEUR'S LICENCE; P.M.G. Certificates; the R.T.E.B. Servicing Certificates; etc. Also courses in Television; Transistors; Radar; Computers; Servo-mechanisms; Mathematics and Practical Transistor Radio course with equipment. We have OVER 20 YEARS' experience in teaching radio subjects and an unbroken record of exam. successes. We are the only privately run British home study Institute specialising in electronic subjects only. Full details will be gladly sent without any obligation.

SEND FOR FREE BROCHURE TO:

BRITISH NATIONAL RADIO SCHOOL
DEPT 4, RADIO HOUSE · READING · BERKSHIRE

PANL BLACK CRACKLE PAINT

Give your metalwork a really professional finish.
Easily applied by brush. Air drying.

Available by post from

THE BRUCE MILLER CO. LTD
249 COASTAL CHAMBERS
BUCKINGHAM PALACE ROAD SW1

4/- per $\frac{1}{2}$ pint can which includes application instructions, postage and packing

CHASSIS and CASES by



287/9 Edgware Road
London W2
TELEPHONE
PADDington 5891/7595

BLANK CHASSIS—Same Day Service
Of over 20 different forms made up to YOUR SIZE.
Order EXACT SIZE you require to nearest 1/16th.
(Maximum length 35", depth 4".)
Specials dealt with promptly.

SEND FOR ILLUSTRATED LEAFLETS
or order straight away, working out total area of material required and referring to table below which is for four-sided chassis in 18 s.w.g. (for 16 s.w.g. add 1/16th).
48 sq. in. 4/- 176 sq. in. 8/- 304 sq. in. 12/-
80 sq. in. 5/- 208 sq. in. 9/- 336 sq. in. 13/-
112 sq. in. 6/- 240 sq. in. 10/- 368 sq. in. 14/-
144 sq. in. 7/- 272 sq. in. 11/- and pro rata
P. & P. 2/6 P. & P. 2/9 P. & P. 3/-
Discounts for quantities. Finishes arranged for quantities of 25 or over.

FLANGES (1/2" or 3/4"), 6d. per bend.
STRENGTHENED CORNERS, 1/- each corner.
PANELS
Any size up to 3ft at 4/6 sq. ft. 18 s.w.g. (16 s.w.g. 5/3).
Plus postage and packing (orders over £2 Post Free).

CASES
ALUMINIUM, SILVER HAMMERED FINISH

Type	Size	Price	Type	Size	Price
U	4 x 4 x 4"	9/6	Y	8 x 6 x 6"	25/-
U	5 1/2 x 4 1/2 x 4 1/2"	14/6	Y	12 x 7 x 7"	39/-
U	8 x 6 x 6"	20/-	Y	13 x 7 x 9"	44/-
U	15 x 9 x 9"	42/6	Y	15 x 9 x 7"	46/-
W	8 x 6 x 6"	19/6	Z	17 x 10 x 9"	63/-
W	12 x 7 x 7"	32/6	Z	19 x 10 x 8 1/2"	67/6
W	15 x 9 x 8"	42/-			

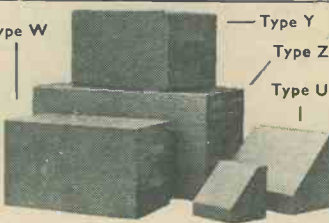

Type Z has removable back and front panels.
Type Y all-screwed construction.

The thrills of VHF Amateur Radio can now be yours for as low as 39/6!—complete kit (by post 2/6 extra)—tunable range, 70–150 Mc/s. Write today for interesting literature, s.a.o. please. If a newcomer to Short-Wave radio, ask for a free copy of world-famous "Globe-King" S.W. kits and other receivers. Home and Overseas Sales.

Johnsons (Radio) St. Martin's Gate Worcester

BRASS · COPPER · DURAL · ALUMINIUM · BRONZE · STAINLESS STEEL

ROD, BAR, SHEET, TUBE, STRIP, WIRE. 3,000 STANDARD STOCK SIZES
No Quantity too small List on application

H. ROLLET & CO LTD
HOWIE ST. LONDON SW11 BATtersea 7872
Also at Liverpool, Birmingham, Manchester, Leeds, Glasgow

THE KING TELEBOOSTER

is now being manufactured and marketed by

TRANSISTOR DEVICES LTD
NEW ROAD, BRIXHAM, DEVON

TO WHOM ALL ENQUIRIES AND ORDERS SHOULD BE ADDRESSED.

Telephone: BRIXHAM 3525

MORSE CODE

Train by the well-known
CANDLER System
of world-wide reputation

YOU TOO CAN BECOME A SKILLED OPERATOR

Learn in your spare time and combine pleasure with success

Special course for Amateur Transmitting Licence. Also courses for Operators

Send 3d. stamp for details: **The CANDLER SYSTEM CO**
Dept. RC, 52b ABINGDON ROAD, LONDON, W.8
Candler System Co., Denver, Colorado, U.S.A.

FANTASTIC BARGAIN OFFER!

ELECTRIC SOLDERING IRON

Lightweight Pistol Grip handle. 40 watt. 240/250v. A.C. Solid copper bit. Detachable handle forms cover for iron when not in use. With 4 1/2 ft. Safety 3-core flex. Indispensable for every home handyman. A boon to model makers and a necessity for every wireless enthusiast. Offered to you at this new amazing price.

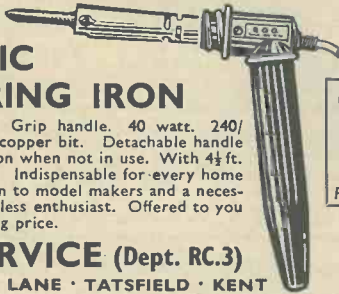

ONLY
9/6
P. & P. 1/-

C. H. SERVICE (Dept. RC.3)
LUSTED HALL LANE · TATSFIELD · KENT

Hammer Finish Paint

A really beautiful effect easily applied by brush. Air dries in 20 minutes. For instrument cases, car accessories, electric fires, etc.

Note for aeromodellers: completely fuel, water and weather proof. Made from one of the finest modern resin systems. 2 1/2 oz. tins in blue, green or pewter, 3/6, post free.

FINNIGAN SPECIALITY PAINTS
5 Stanley Square, Stalybridge, Cheshire

THE RADIO CONSTRUCTOR — BOUND VOLUMES

Volume 16, August 1962 to July 1963 Price £1.10.0. Postage 2s. 9d.

Where all issues are returned: Price £1. Postage 2s. 9d.

Also available Volume 13, August 1959 to July 1960 Price £1.5.0. Postage 2s. 3d.

We regret Volumes 14 and 15 are now sold out

DATA PUBLICATIONS LTD 57 MAIDA VALE LONDON W9

TRANSISTORS, CRYSTALS, VALVES, COMPONENTS & EQUIPMENT

FOR THE AMATEUR & PROFESSIONAL—TRADE SUPPLIED—QUOTATIONS BY RETURN

ALL LINES PREVIOUSLY ADVERTISED STILL AVAILABLE FROM STOCK

- ★ Stethoscope Headsets Mono Crystal or Magnetic, 10/6, Stereo Magnetic, 27/6.
- ★ New fully retractable car radio aerial, tamper proof (usually 55/-) 35/-, p.p. 1/6.
- ★ Transistor insulation tester, £17.10.0.
- ★ Recording tape. Best American and Canadian quality. 5" 600', 12/6; 5" 900', 15/-; 7" 1,200', 18/6. 7" 1,800', 25/-; 2,400' 7", 27/6.
- ★ 10 watt horn tweeter, 29/6, p.p. 1/6.
- ★ Portable oscilloscope, £16.10.0.
- ★ Transistor portable baby alarm, £5.10.0.

- ★ Signal Injector transistorised, 39/6.
- ★ High output telephone amplifier, £5.10.0.
- ★ Ready-built transistor superhet tuner, 82/6.
- ★ 5-transistor 350mW 9 volt 15Ω amplifier, 57/6
- ★ Large range of TSL pre-built FM units in stock. Also AM and AM/FM units.
- ★ Panel meters. 50μA, 39/6; 500μA 32/6; 1mA, 5mA, 300 volt, 27/6 each. New miniature types, clear plastic or black moulded fronts—Brand new and boxed.
- ★ 5 hole chassis punch kit, 49/6, p.p. 1/6.



MULTI-METERS

Multi-range test meters featuring easy to read scales and provided with full operating instructions, lead and batteries. Suitable for amateurs, designers, repair shops, all domestic uses. Full details and specification in our catalogue.

- ★ PT34, 1kΩ/volt £2.50
- ★ M1, 2kΩ/volt £2.96
- ★ THL33, 2kΩ/volt (illus.) ... £3.15.0
- ★ EP10K, 10kΩ/volt £4.96
- ★ ITI-2, 20kΩ/volt £5.50
- ★ TP55, 20kΩ/volt £5.19.6
- ★ EP30K, 30kΩ/volt £6.19.6
- ★ 500, 30kΩ/volt £8.19.6
- ★ EP50K, 50kΩ/volt £9.19.6

RUN YOUR RADIO OR AMPLIFIER FROM MAINS BATTERY ELIMINATORS AND CHARGERS

1. For PP3 or equivalent 9 volt Pocket Radio Battery, 18/6. P.P. 1/-.
2. For PP4, PP7, PP9, 9 volt Portable Radio and Equipment. Supplies up to 300mA, 49/6. P.P. 2/-.
3. De Luxe version of No. 1, also charges PP3 type batteries, 24/- P.P. 1/-.

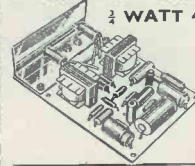

1/2 WATT 4 TRANSISTOR AMPLIFIER

- ★ Improved Version. 1 1/2 watt peak output. ±3dB 70 c/s to 12 kc/s. Output to 3 ohm speaker 9 volt operated.

Built and Tested 49/6 or Kit of Parts 39/6 P.P. 1/6 P.P. 1/6
● NEW LOW PRICE ●

Details on request.

NEW 84 PAGE FULLY DETAILED AND ILLUSTRATED CATALOGUE. PRICE 2/-

★ PRICE REDUCTIONS — NEW TYPES ALL BRAND NEW STOCKS

Crystal Contact Microphone, 12/6. P.P. 9d.
2K, 1/2-track Tape Head, 15/- P.P. 9d.
Telephone Recording Attachment, 12/6.
4-channel Transistor Mixer Unit, 59/6.
Tape Jack Radio Tuner, 29/- P.P. 1/-

TAPE RECORDERS

- ★ COLLARO STUDIO 2-TRACK DECK, £10.10.0. P. & P. 5/-.
 - ★ 4-TRACK DECK, £13.19.6 P. & P. 5/-.
 - ★ CABINET with SPEAKER for above, 5 gns. P. & P. 2/-.
 - ★ RECORD/PLAY AMPLIFIER KITS, 2 track, 11 gns. 4 track, 12 gns.
- Leaflet on Request.

MAINS DECKS

- ★ GARRARD AUTOSLIM, 4 speed changer, £6.10.0.
 - ★ PLUG IN HEAD VERSION, £6.19.6.
 - ★ Stereo Version, £7.10.0.
 - ★ GARRARD AT6 STEREO £10.19.6. Mono £10.10.0.
 - ★ B.S.R. UA14 4 speed, £5.19.6. UA15, £6.5.0.
 - ★ GARRARD SRP10 or BSR GU7—4-Speed Single Player, £5.5.0.
- All complete with cartridge.

BATTERY DECKS

- ★ STAR 45 r.p.m., 39/6. P. & P. 2/6.
 - ★ GARRARD 45 r.p.m., 35/- P. & P. 2/-.
 - ★ STAR 45 and 33 r.p.m., 92/6.
 - ★ B.S.R. GU7 4 speed, 5 gns. P. & P. 2/6.
- All decks fitted Crystal pick-ups.

QUALITY MICROPHONES

- Acos 60 Stick Microphone ... 27/6
 - Acos 39-1 Stick Microphone ... 32/6
 - Acos 40 Desk Microphone ... 15/-
 - Acos 45 Hand Microphone ... 22/6
 - Lapel/Hand Microphone ... 12/6
 - 100C Stick with Stand ... 39/6
 - BM3 Stick with Stand ... 49/6
 - Lapel/Hand Magnetic ... 8/6
 - Dynamic Stick Microphone ... 5 gns
 - Dynamic Hand/Desk Microphone with stand ... 52/6
- Post and Packing 1/6 any type.

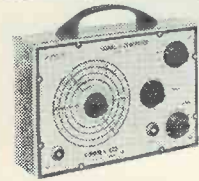

★ NOMBREX ALL TRANSISTOR SIGNAL GENERATOR. 150 kc/s to 350 Mc/s. AF, RF Mod., etc., £9.10.0, with leads, batt., etc.

★ NOMBREX TRANSISTORISED RESISTANCE CAPACITANCE BRIDGE. 1pF to 100 mfd., 1 ohm to 100 meg., leakage test, visual null indicator, £8.5.0, with batt.

★ NOMBREX TRANSISTOR POWER SUPPLY UNIT. 1 to 15 volts D.C. up to 0.1 amp. 230/250V, A.C. mains, £6.10.0.

Post and Packing 2/6 any type.

(Note increased prices as recently announced by makers.)

★ DETAILED LEAFLETS ON REQUEST ★

SINCLAIR DESIGNS

- Sinclair 'Slimline' 46/6
- Sinclair Micro-6 59/6
- Sinclair Micro-Injector 27/6
- 5-transistor Amplifier, 9 volt 57/6

All parts in stock for PW, TSL, Repanco, Radio Constructor, RCME, etc., designs.—Quotations by return.

AUDIO KITS FROM STOCK. NEW RANGE OF MARTIN AUDIO KITS. ALL TRANSISTOR UNITS. ALSO MARTIN RECORDAKITS AND TAPE PRE-AMPS. DETAILS ON REQUEST.

QUALITY STEREO HEADPHONES

8 + 8 ohms 62/6

HI-FI SPEAKERS

- 12" 15 ohms, 12,000 G. 35/-
- 8", 15/16 ohm (BA7) 78/6
- 12", 15/16 ohm (CR30AE) 10 gns
- 20 watt rectangular horn tweeter ... 69/6

★ TRANSISTOR POCKET RADIOS

Ready to use, complete with Battery, Leather Case, Earphone. P.P. 2/- any type.

- 6-Transistor Zephyr 79/6
- 6-Transistor De Luxe 85/-
- 7-Transistor Zephyr 89/6
- 6-Transistor MW/LW £5.19.6

★ 50-0-50μA EDGE TYPE METER

Complete with circuit for use as stereo balance meter, 25/-, p.p. 1/-.

SUBSTITUTION BOXES

★ Capacitor Box. Provides 9 standard values from 0.001 to 0.22 mfd. at 600 volt working, 29/6.

★ Resistor Box. Provides 24 standard values at 1 watt. 15 ohms to 10 meg., 37/6. Each box fully calibrated with insulated leads. Invaluable for service and design.

QUARTZ CRYSTALS

- 100 kc/s 3 pin ... 15/-
- 500 kc/s 2 Pin ... 15/-
- 455 kc/s (AR88) ... 12/6
- 5,000 kc/s 2 Pin ... 10/-
- 10 Mc/s 2 Pin ... 15/-
- 27.255 Mc/s ... 15/-
- HC6U 18 Mc/s to 46 Mc/s, 7/6. 80 frequencies 0.005% Acc. Over 800 frequencies in stock for all uses.

FIELD STRENGTH METER

Measures transmitter carrier waves from 1 Mc/s to 200 Mc/s in 5 switched fully adjustable ranges. Contains 200μA meter for carrier level and earphone for modulation. Requires no connection to transmitter. Self-contained, ready for use, 69/6, post free.

GARRARD BATTERY TAPE DECK

Two-speed, 9 volt, £11.15.0, post and packing 3/6.

HENRY'S RADIO LTD

PADDINGTON 1008/9

303 EDGWARE RD., LONDON, W2

Open Monday to Sat. 9-6, Thurs. 1 o'clock

PLEASE TURN TO BACK PAGE

We can supply from stock most of the components and items specified on circuits published in this and other magazines and radio books. Let us quote for your circuit.

HENRY'S RADIO LTD
303 EDGWARE ROAD LONDON W2
PADdington 1008/9
Open Monday to Sat. 9-6. Thurs. 1 o'clock

NEW CATALOGUE
84 PAGES, 10" x 7½"
Up to date with new items and many price reductions.
Fully detailed and illustrated, Price 2/-

10 WATT TRANSISTOR HI-FI EQUIPMENT



GUARANTEED HIGH PERFORMANCE UNITS

● PRINTED CIRCUIT CONSTRUCTION ●

★ **POWER AMPLIFIERS**—Two versions. 6-Transistor and Rectifier on 4 x 2½-inch panels. ±1dB 40 c/s to 20kc/s. 100mV input for 10 watts with 0.25% distortion at 400 c/s. 60dB feedback. 3 and 15 ohm versions. Low current, only 300mA and 150mA respectively.

● 3 ohm 10 watt Built **£5.10.0** P.P. 2/6
● 15 ohm 10 watt Built **£5.19.6** P.P. 2/6

● Mains units for either of above **69/6**—will run two amplifiers. Any type P.P. 2/6

COMPLETE CIRCUIT DIAGRAMS FREE ON REQUEST

★ **PRE-AMPLIFIER AND CONTROL UNIT.** For use with either of above amplifiers or valve types—Hum-free—2½mA drain—Battery operated or from above mains units—8 inputs between 1.5mV and 300mV—for all pick-ups, microphones, tuners, tape replay, separate treble, bass and volume with cut and boost—4-position low pass filter—40 c/s roll off, etc. Panel size 9 x 2½".

● CALL FOR DEMONSTRATION AND HEAR GUARANTEED HIGH PERFORMANCE ●

PERFORMANCE EQUAL TO VALVE UNITS OF FOUR TIMES THE PRICE AND MANY TIMES THE SIZE

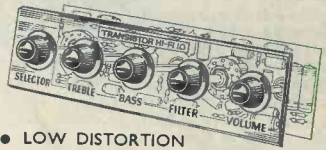

- LOW DISTORTION
- HIGH GAIN
- MAINS OR BATTERY
- LOW NOISE
- MONO OR STEREO
- PRE-AMPLIFIER Built **£5.10.0** P.P. 2/6
- Dark brown and gold panel plate 8/6

TRADE DISCOUNTS AVAILABLE—SEND FOR DETAILS

MINIGRAM TRANSISTOR PORTABLE RECORD PLAYER



● Made by well known British manufacturer. Features ready built 4-transistor printed circuit, 1 watt amplifier, elliptical speaker and volume control. Low current Star, constant speed 45 r.p.m. turntable with crystal pick-up. Strong moulded two-colour cabinet with handle. Plays

anywhere on long life 9 volt battery. Requires less than half an hour's work to connect up using ready built units and easy instructions.

TOTAL COST **79/6** P.P. 5/- (Battery 3/9)

MARTIN RECORDAKIT BUILD A QUALITY PORTABLE TAPE RECORDER

Complete in every detail.

● Pre-built units — Collaro Studio Decks — Portable Cabinets with Speakers. 6 valve designs.

TWO TRACK

Total Cost **£26** P.P. 8/6

FOUR TRACK

Total Cost **£30** P.P. 8/6

ALL AUDIOKITS IN STOCK

★ Leaflets on Request ★

VHF FM TRANSISTOR TUNER

(As described in December 1963 Edition of "Radio Constructor".)

- ★ 5-Transistor
- ★ 4 Diodes
- ★ Full coverage 87 to 105 Mc/s
- ★ AFC and AVC

Printed circuit design of high sensitivity and quality. Output for valve or transistor amplifiers. Size 3½" x 2½" x 4". Simplified building instructions. All parts sold separately.

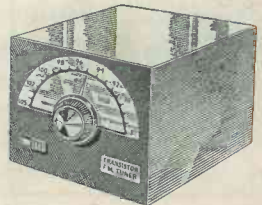

TOTAL COST

£7.19.6 P.P. 2/6

(Cabinet assembly 20/- extra)

Detailed Circuit Book on Request

4-WAVEBAND COMMUNICATIONS RECEIVER

● 550 kc/s to 30 Mc/s—BFO — AVC — Noise Limiter — Band spread — "S" Meter — Telescopic Aerial — Full Worldwide Coverage — 4 valve. PRICE **£24.15.0**. With Full Instructions.

BRAND NEW IN CAR-TONS. Detailed Leaflets on request.

● 9 valve version of above 40 gns. Details on request.



TOTAL COST OF ALL PARTS

£9.19.6 P.P. 3/6

Fully Detailed and Illustrated Leaflet on request.

All parts sold separately. Guaranteed the Best Obtainable. Attractive Appearance. Reliable Design. Quality Performance.

UNBEATABLE FOR QUALITY AND VALUE

'THE CONTESSA'

★ COMBINED PORTABLE AND CAR RADIO ★

AMAZING SENSITIVITY AND SELECTIVITY ON MEDIUM AND LONG WAVEBANDS

★ The easiest Superhet Radio to build on the market. Features clearly-marked printed circuit and packaged components with full illustrated building instructions. Full tuning of medium and long wave bands with unbeatable sensitivity and selectivity. Excellent tone and volume with over 600mW push-pull output.

★ Clearly marked horizontal station dial with slow motion tuning. Two-colour Blue or Beige cabinets with Gold handles, grilles and fittings. Size 10½" x 7½" x 5½", includes car aerial sockets, recording sockets.

★ 6 Mullard Transistors and 2 Diodes.

7-TRANSISTOR RECORD PLAYER/RADIOGRAM AMPLIFIER

- 4 watt peak output
- Full Treble and Bass boost and cut
- 40 c/s to 20 kc/s ±3dB
- Inputs for Pick-ups, Radio Tuners, Microphones, Mixers



★ TWO VERSIONS AVAILABLE

12/18 volt for 15 ohm speakers (mains unit now 60/- extra)
9/12 volt for 3 ohm speakers (mains unit 49/6 extra)

● Size only 6" x 25" x 2" Ideal for mains or battery, portable or domestic record player, grams, etc. Or car.

Built Ready To Use **£5.19.6** P.P. 2/-

PLEASE TURN TO NEXT PAGE